

DEPARTMENT OF HUMANITIES AND SCIENCES

B.Tech I Year I&II Semester

CHEMISTRY

Subject Code: 23HBS9907

Regulation: HM23



ANNAMACHARYA INSTITUTE OF TECHNOLOGY AND SCIENCES

(Autonomous)

(Affiliated to J.N.T.U.A, Anantapur, Approved by A.I.C.T.E, New Delhi)

Utukur (P), C.K.Dinne (V&M), Kadapa-516003

Accredited by NAAC with 'A' Grade, Bangalore.



**ANNAMACHARYA INSTITUTE OF TECHNOLOGY & SCIENCES::KADAPA
(AUTONOMOUS)**

(Approved by AICTE New Delhi & Affiliated to JNTUA, Anantapuramu)
Accredited by NAAC with 'A' grade, Bangalore

CHEMISTRY

(Common to EEE, ECE, CSE) & allied branches

Course Objectives:

- To familiarize engineering chemistry and its applications.
- To train the students on the principles and applications of electro chemistry and polymers .
- To introduce instrumental methods.

Course Outcomes: At the end of the course, the students will be able to:

CO1: Compare the materials of construction for battery and electrochemical sensors.

CO2: Explain the preparation, properties, and applications of plastics, elastomers & conducting polymers.

CO3: Explain the principles of spectrometry, separation of solid and liquid mixtures.

CO4: Apply the principle of Band diagrams in the application of conductors and semi conductors.

CO5: Summarize the concepts of Instrumental methods.

UNIT I Structure and Bonding Models:

Planck's Quantum theory, Dual nature of matter, Schrodinger Wave equation, significance of Ψ and Ψ^2 , Application to hydrogen, molecular orbital theory – bonding in homo- and hetero nuclear diatomic molecules – energy level diagrams of O_2 and CO , etc. π -molecular orbitals of butadiene and benzene, calculation of bond order.

UNIT II Modern Engineering Materials:

Semi conductors-Introduction,basicconcept, applications. Band diagrams for conductors, semi-conductors, insulators. Effect of doping on band structures. Super conductors –Introduction , basic concept, applications. Super capacitors: Introduction, Basic Concept-Classification – Applications. Nano materials: Introduction, classification, preparation, properties and applications of Fullerenes, carbon nano tubes and Graphines nano particles.

UNIT III Electrochemistry and Applications

Electro chemical cell, Nernst equation, cell potential calculations, numerical problems, Potentiometry - potentiometric titrations (redox titrations), concept of conductivity, conductivity cell, conductometric titrations (acid-base titrations).

Electro chemical sensors- potentiometric sensors, amperometric sensors with examples.

Primary cells – Zinc-air battery, Fuel cells -hydrogen-oxygen, methanol-oxygen fuel cells – working of the cells. Secondary cells– Nickel-Cadmium (Ni-Cd) and lithium ion batteries-working of the batteries including cell reactions.

UNIT IV Polymer Chemistry

Introduction to polymers, functionality of monomers, chain growth and step growth polymerization, copolymerization with specific examples and mechanisms of polymer formation.

Plastics - Thermoplastics and Thermosetting. Preparation, Properties and applications of PVC, Teflon, Bakelite and Nylons .

Elastomers – Buna-S, Buna-N : preparation, properties and applications.

Conducting polymers – polyacetylene, polyaniline – mechanism of conduction and applications.

Biodegradable polymers- Poly (Glycolic Acid) (PGA), Poly (Lactic Acid) (PLA)

UNIT V Instrumental Methods and Chromatography

Electromagnetic spectrum. Absorption of radiation: Beer-Lambert's law. Principle and applications of pH metry, UV-Visible and IR Spectroscopies.

Chromatography - classification , Solid-Liquid Chromatography - principle, applications of Thin Layer Chromatography (TLC), retention time. Principle, instrumentation and applications of HPLC.

Textbooks:

1. Engineering Chemistry, Jain and Jain, 16th Edition, 2013, Dhanpatrai.
2. Engineering Chemistry, K. N. Jayaveera, G. V. Subba Reddy and C. Ramachandraiah, First Edition, 2013, McGraw Hill Higher Education.
1. Peter Atkins, Julio de Paula and James Keeler, Atkins' Physical Chemistry, 10/e, Oxford University Press, 2010.

Reference Books:

1. Skoog and West, Principles of Instrumental Analysis, 6/e, Thomson, 2007.
2. J.D. Lee, Concise Inorganic Chemistry, 5th Edition, Wiley Publications, Feb. 2008.
3. Text book of Polymer Science , Fred W. Billmeyer Jr, 3rd Edition.

UNIT-I

1. Planck's Quantum Theory: The quantum theory of radiations was proposed by Max Planck in 1900 to explain the phenomenon of black body radiation.

- (i) The energy is absorbed or emitted by a body not continuously but discontinuously, in the form of small packets.
- (ii) Each packet of energy is called a quantum. In case of light, the quantum of energy is called photon.
- (iii) The energy of quantum is not fixed. It is directly proportional to the frequency (ν) of radiation (light).

$$E \propto \nu \text{ (or) } E = h\nu \quad h = \text{Planck Constant}$$
$$\therefore h = 6.625 \times 10^{-27} \text{ erg. sec.} = 6.625 \times 10^{-34}$$

($10^7 \text{ ergs} = 1 \text{ Joule}$)

(iv) A body can emit (or) absorb either one quantum of energy ($h\nu$) (or) some whole number multiple of it. Thus radiant energy can be emitted as $h\nu$, $2h\nu$, $3h\nu$, and so on.

2. Dual nature of matter and Radiation

- (i) Dual character of radiation: Light has dual character
- (a) Wave nature (b) Particle nature
- (a) Wave nature: According to wave theory, light travels as wave in the form of crests and troughs.

[According to bhr particle is electrons]

According to de-Broglie, all the matter particles like electrons, protons, neutrons, atoms should have not only the particle nature but also the wave nature. The wave length of the matter particle (electron) in motion is given by

$$\lambda = \frac{h}{mv} \quad (\text{or}) \quad \frac{h}{p}$$

λ = wave length

m = mass of the electron

h = Planck's constant

p = momentum of electron

The above equation is known as de-Broglie's wave equation, which is derived from Planck's quantum theory and Einstein mass-energy relation.

According to Max Planck's Quantum theory

$$E = h\nu$$

$$= \frac{hc}{\lambda} \quad \left[\because \nu = \frac{c}{\lambda} \right] \quad \text{--- (1)}$$

According to Einstein mass energy relation

$$E = mc^2 \quad \text{--- (2)}$$

Comparing the two equations

$$\frac{hc}{\lambda} = mc^2$$

$$\lambda = \frac{h}{mc}$$

If 'c' is replaced with the velocity of electrons 'v', then

$$\lambda = \frac{h}{mv} \quad (\text{or}) \quad \lambda = \frac{h}{p}$$

As per this theory, an electron is not a point mass moving in an orbit but a standing wave extending around the nucleus in a circular fashion.

(Electron wave in a circular path)

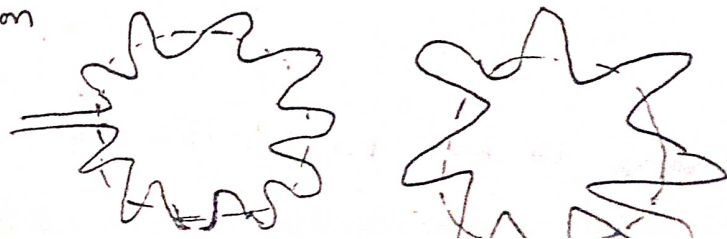

SCHODINGER EQUATION

Keeping in view the wave and particle nature of electron a new model known as wave mechanical model was developed by Erwin Schrodinger. He considered the electron as three-dimensional wave in electric field. To describe the behaviour of electron waves Schrodinger developed a mathematical equation which is popularly known as Schrodinger wave equation.

$$\frac{\partial^2 \psi}{\partial x^2} + \frac{\partial^2 \psi}{\partial y^2} + \frac{\partial^2 \psi}{\partial z^2} + 4\pi^2 \nu^2 \psi = 0 \quad \text{--- (1)}$$

According to non-classical de-Broglie's equation

$$\lambda = \frac{h}{mv} \quad \text{where } \nu = \frac{v}{\lambda}$$

$$\frac{1}{\lambda} = \frac{mv}{h} = \frac{\nu}{v}$$

ν = wave number

$$\nu = \frac{1}{\lambda}$$

$$\nu^2 = \left(\frac{1}{\lambda}\right)^2$$

Substituting in eq. (1)

$$\frac{\partial^2 \psi}{\partial x^2} + \frac{\partial^2 \psi}{\partial y^2} + \frac{\partial^2 \psi}{\partial z^2} + 4\pi^2 \left(\frac{mv}{h}\right)^2 \psi = 0$$

$$\frac{\partial^2 \psi}{\partial x^2} + \frac{\partial^2 \psi}{\partial y^2} + \frac{\partial^2 \psi}{\partial z^2} + 4\pi^2 \frac{m^2 \nu^2}{h^2} \psi = 0 \quad \text{--- (2)}$$

But Kinetic energy $K.E = \frac{1}{2} m v^2$ (or) $m^2 \nu^2 = 2mK.E$

Substituting in the eq. (2)

$$\frac{\partial^2 \psi}{\partial x^2} + \frac{\partial^2 \psi}{\partial y^2} + \frac{\partial^2 \psi}{\partial z^2} + \frac{8\pi^2 m K.E}{h^2} \psi = 0$$

But the total energy $E = K.E + P.E.$ (or) $E = \frac{1}{2} m v^2 + V$

Hence $K.E. = E - P.E. (V)$

$$\therefore \frac{\partial^2 \psi}{\partial x^2} + \frac{\partial^2 \psi}{\partial y^2} + \frac{\partial^2 \psi}{\partial z^2} + \frac{8\pi^2 m (E - V)}{h^2} \psi = 0$$

$$\nabla^2 \psi + \frac{8\pi^2 m}{h^2} (E - V) \psi = 0$$

$\nabla^2 = \left[\frac{\partial^2}{\partial x^2} + \frac{\partial^2}{\partial y^2} + \frac{\partial^2}{\partial z^2} \right]$ is called Laplace operator.

Here m = mass of e

V = Potential e

E = Total ene

h = Planck's c

x, y, z are Cartesian Co.

- Particle and probability character of the measurements.

Significance of ψ :

- (i) ψ is a wave function
- (ii) It gives the information about the amplitude of wave function
- (iii) It may have +ve value (or) -ve value (or) zero

Significance of ψ^2 :

- ① It is a probability factor
- ② It gives the information about probability of finding an electron with in small region around the nucleus.
- ③ It leads to the idea of orbital.

Schrodinger Wave Equation for H-atom: (i) Application to H-atom

Hydrogen atom contains one electron around the nucleus of charge +e and charge on the electron is -e.

Potential energy of electron, is given as $V = \frac{-e^2}{r}$

Substituting the value of V , in the Schrodinger equation

$$\text{we get } = \frac{\partial^2 \psi}{\partial x^2} + \frac{\partial^2 \psi}{\partial y^2} + \frac{\partial^2 \psi}{\partial z^2} + \frac{8\pi^2 m}{h^2} \left(E + \frac{e^2}{r} \right) \psi = 0$$

$$\left(\frac{\partial^2}{\partial x^2} + \frac{\partial^2}{\partial y^2} + \frac{\partial^2}{\partial z^2} \right) \psi + \frac{8\pi^2 m}{h^2} \left(E + \frac{e^2}{r} \right) \psi = 0$$

$$\therefore \boxed{\nabla^2 \psi + \frac{8\pi^2 m}{h^2} \left(E + \frac{e^2}{r} \right) \psi = 0}$$

Molecular orbital theory:

- (i) Molecular orbitals are formed by overlapping of atomic orbitals of nearly same energy.
- (ii) The number of molecular orbitals formed are equal to the number of atomic orbitals involved in overlapping.
- (iii) Molecular orbitals, like atomic orbitals, are characterised by set of quantum numbers.
- (iv) Half of the molecular orbitals will have lower energy and called bonding molecular orbitals, other half are higher energy and termed as antibonding molecular orbitals.
- (v) Electronic configuration in molecular orbitals will be based on three rules i.e (a) Aufbau's rule (b) Hund's rule (c) Pauli's exclusion principle.
- (vi) The Linear Combination of atomic orbitals (LCAO) results in two types of
 - (a) Bonding molecular orbitals
 - (b) Antibonding molecular orbitals
- (vii) The bonding molecular orbital has a low energy compared to the atomic orbitals. Therefore it results in the formation of bond.
- (viii) The antibonding molecular orbitals has higher energy compared to the atomic orbitals. Such an orbital cannot form a stable bond.
- (ix) The formation of bonding and anti-bonding is represented as below.

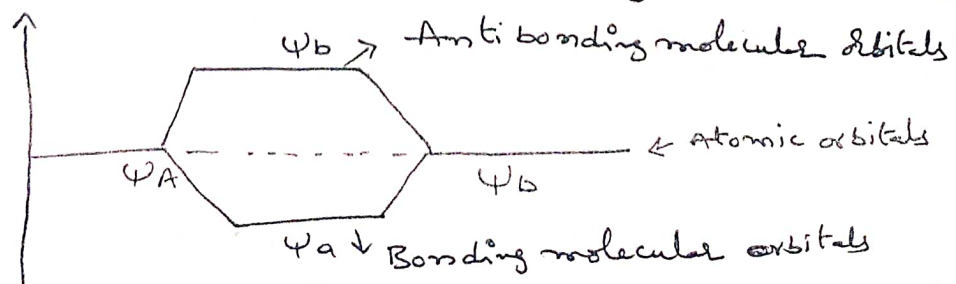

(x) The order of increasing energy for the orbital is

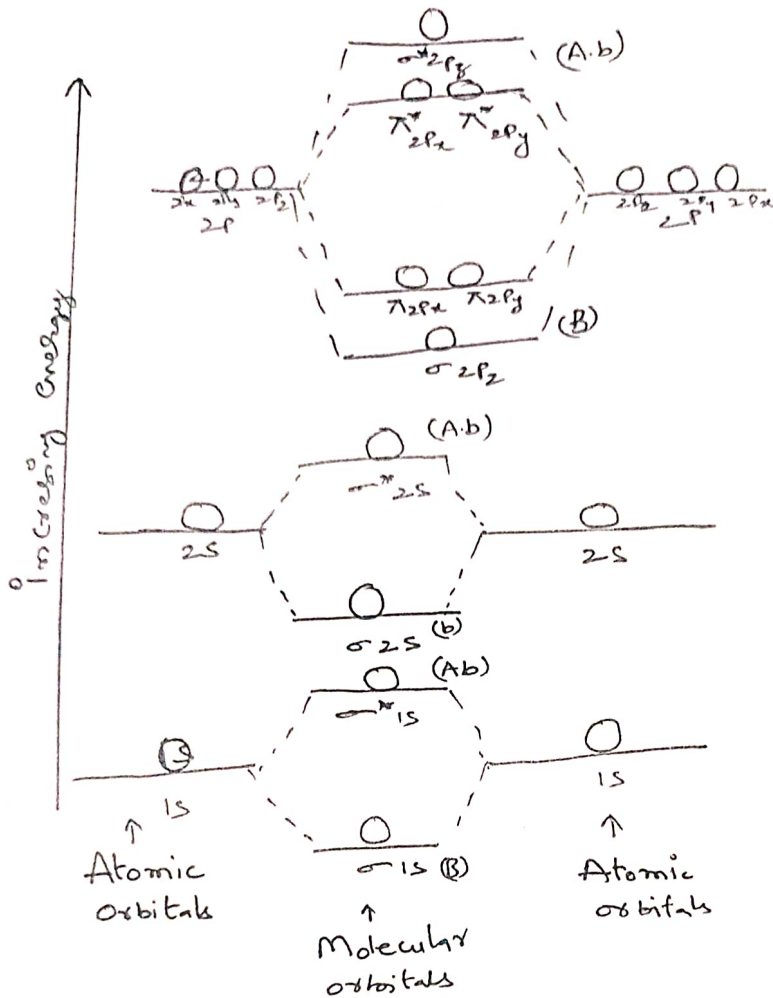
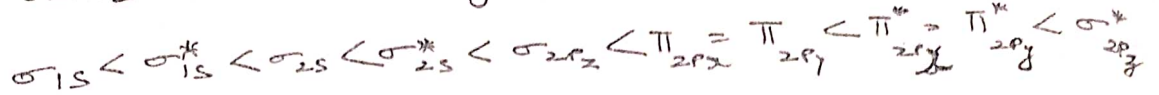

Bond order :

Bond order is defined as half the difference between the number of electrons in the bonding molecular orbitals and in the antibonding molecular orbitals

$$\therefore \text{Bond order} = \frac{1}{2} \left[\text{Number of electrons in bonding M.O (N}_b) - \text{Number of electrons in antibonding M.O (N}_a) \right]$$

$$\therefore \text{Bond order} = \frac{1}{2} [N_b - N_a]$$

Bond length : Bond length is the distance between the centres of two bonded nuclei. It is inversely proportional to bond order.

$$\text{Bond length} \propto \frac{1}{\text{Bond order}}$$

∴ i.e. bond order increases ...

(4)

Bonding in homo and heteronuclear diatomic molecules:

(1) Bonding in homo nuclear diatomic molecules:-

(a) Hydrogen molecule: Hydrogen molecule is having two hydrogen atoms containing each one electron ($1s^1$)

M.O. diagram

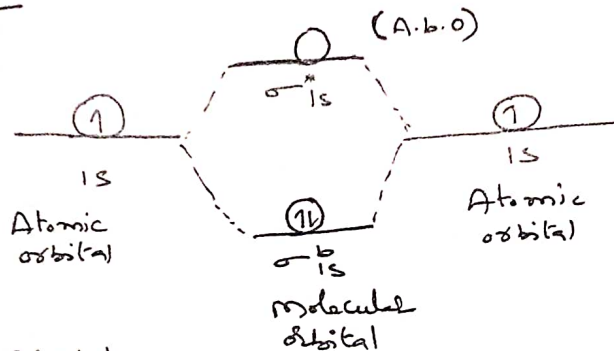

Molecular orbital configuration of $H_2 = (\sigma_{1s})^2 (\sigma_{1s}^*)^0$

$$\text{Bond order} = \frac{1}{2} [N_b - N_a]$$

$$\text{Bond order} = \frac{1}{2} [2 - 0] = 1$$

(b) H_2^+ ion: It is made up of H atom containing one electron and H^+ ion containing no electron.

M.O. diagram:

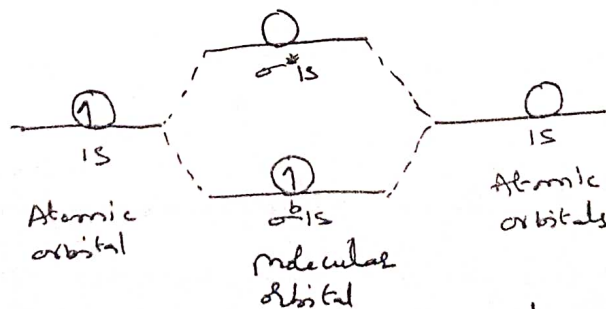

M.O. configuration of $H_2^+ \text{ ion} = (\sigma_{1s})^1 (\sigma_{1s}^*)^0$

$$\text{Bond order} = \frac{1}{2} [N_b - N_a]$$

$$\text{Bond order} = \frac{1}{2} [1 - 0] = \frac{1}{2}$$

Helium molecule (He_2)

$$\frac{\text{He}}{2} + \frac{\text{He}}{2} = 4$$

Each helium atom contains 2 electrons.

M.O. diagram

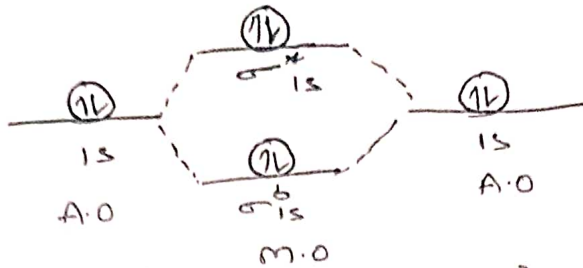

$$\text{M.O. Configuration of } \text{He}_2 = (\sigma_{1s})^2 (\sigma_{1s}^*)^2$$

$$\text{Bond order} = \frac{1}{2} (N_b - N_a) = \frac{1}{2} [2 - 2] = 0$$

$$\text{Bond order} = 0$$

Lithium molecule (Li_2): Each lithium atom has electronic configuration of $1s^2 2s^1$ and so Li_2 molecule has six electrons. In the molecular orbital formation, the electrons of the inner shell (K-shell) do not enter in bonding. $\frac{\text{Li}}{1} + \frac{\text{Li}}{1} = 2$

M.O. diagram

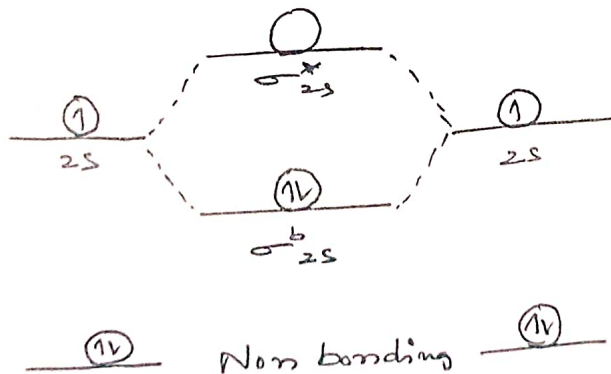

$$\text{M.O. Configuration of } \text{Li}_2 = (\text{KK}) (\sigma_{2s})^2 (\sigma_{2s}^*)^0$$

$$\text{Bond order} = \frac{1}{2} [N_b - N_a] = \frac{1}{2} [2 - 0] = 1$$

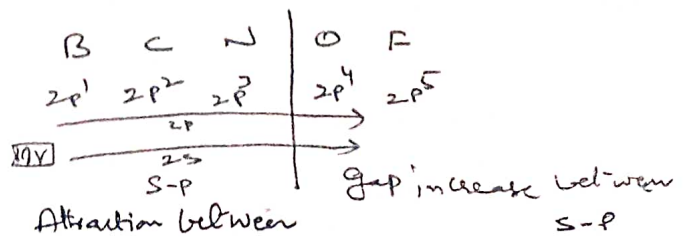

(5)

Oxygen molecule (O₂) Each oxygen atom has 8 electrons and oxygen molecule has total 16 electrons.

M.O. diagram

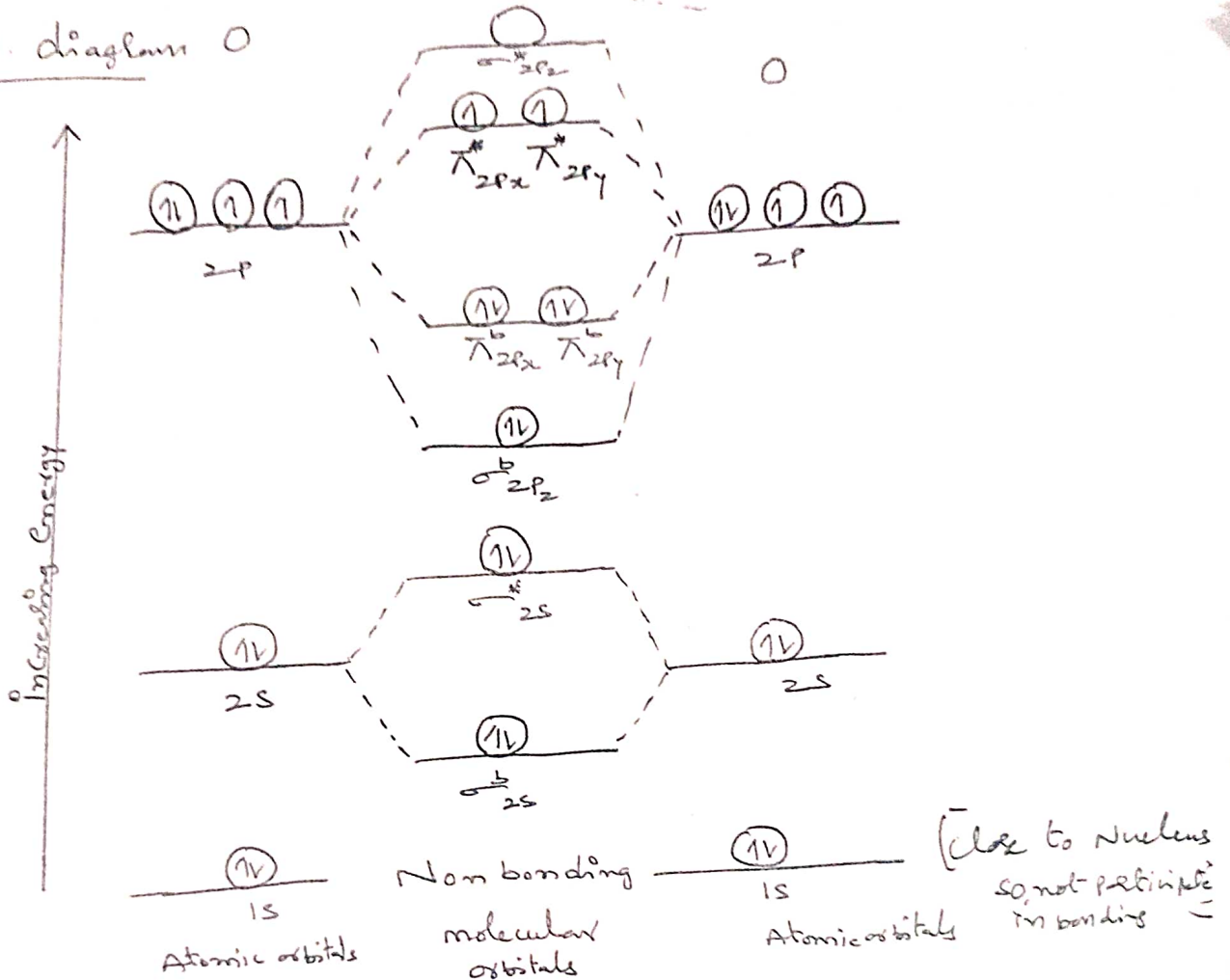

M.O. electronic Configuration = $(\sigma_{2s})^2 (\sigma_{2s}^*)^2 (\sigma_{2p_z})^2 (\pi_{2p_x})^2 (\pi_{2p_y})^2 (\pi_{2p_x}^*)^1 (\pi_{2p_y}^*)^1$

Bond Order = $\frac{1}{2} [N_b - N_a] = \frac{1}{2} [8 - 4] = 2$

Bond order = 2 i.e. it has double bond

Heteronuclear molecules

CO (Carbon monoxide) It possesses 10 valance electrons.

(4 by Carbon and 6 by oxygen atom.)

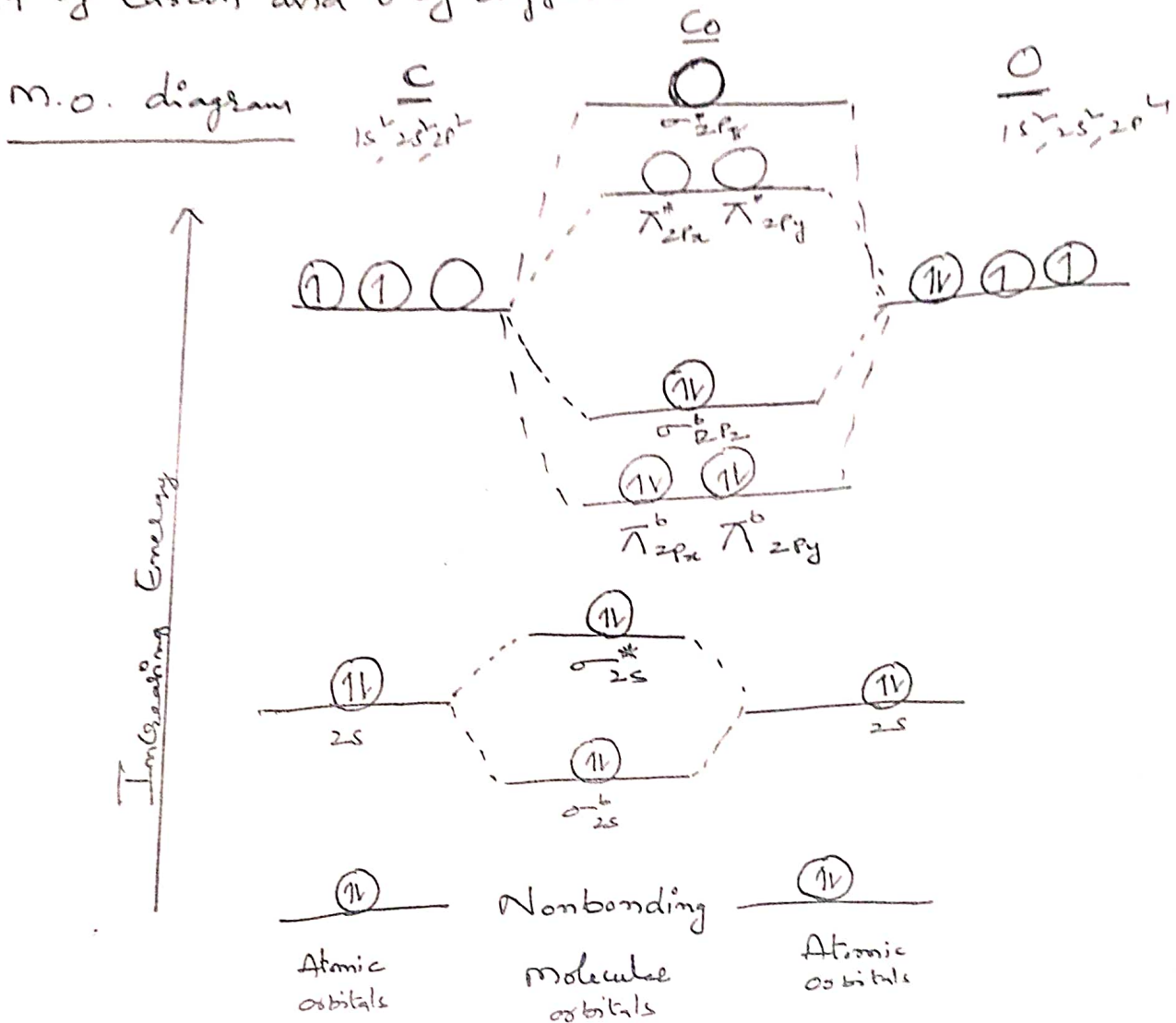

M.O. electronic Configuration = $KK (\sigma_{2s})^2 (\sigma_{2s}^*)^2 (\pi_{2p_x})^2 (\pi_{2p_y})^2 (\sigma_{2p_z})^2$

Bond order = $\frac{1}{2} [N_b - N_a] = \frac{1}{2} [8 - 2] = 3$ (Triple bond)

NO (Nitric oxide): Nitric oxide has 11 valance electron, 6 by oxygen atoms and 5 by nitrogen atom.

M.O. electronic Configuration = $KK (\sigma_{2s})^2 (\sigma_{2s}^*)^2 (\pi_{2p_x})^2 (\pi_{2p_y})^2 (\sigma_{2p_z})^2 (\pi_{2p_x}^*)^1$

Bond order = $\frac{1}{2} [N_b - N_a] = \frac{1}{2} [8 - 3] = 2 \frac{1}{2}$

MO Diagram of NO

It possesses 11 valence electrons. 5 by Nitrogen and 6 by oxygen atom

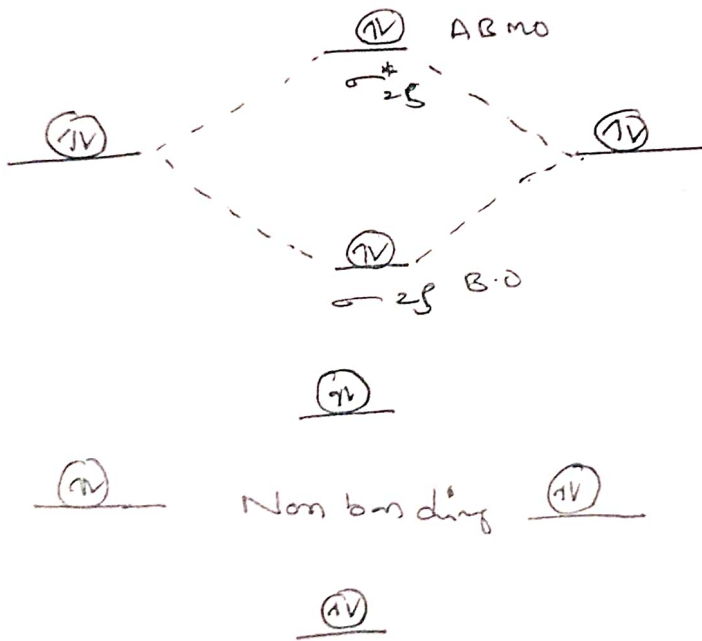
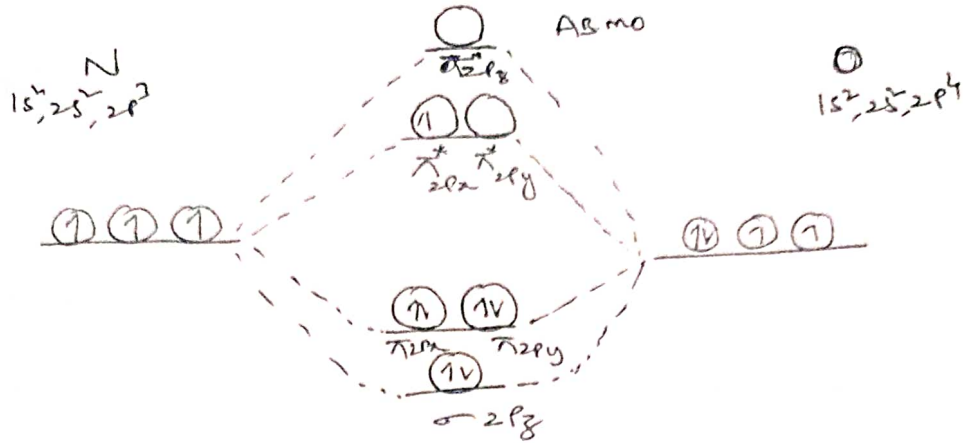

$$\text{Bond order} = \frac{1}{2} [N_b - N_a] = \frac{1}{2} [8 - 3] = 2\frac{1}{2}$$

$$\text{M.O. electron configuration} = KK (\sigma_{2s})^2 (\sigma_{2s}^*)^2 (\sigma_{2p})^2 (\pi_{2p_x})^2 (\pi_{2p_y})^2 (\pi_{2p_x}^*)^0 (\pi_{2p_y}^*)^0 (\sigma_{2p_z}^*)^0$$

Molecular orbitals of Benzene and Butadiene

1. Benzene :-

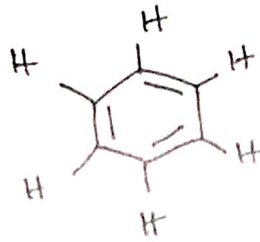

We know that benzene has a planar hexagonal structure in which all the six carbon atoms are sp^2 hybridized. The remaining cyclic array six p-orbitals (one on each carbon) overlap to generate six molecular orbitals, three bonding and three antibonding.

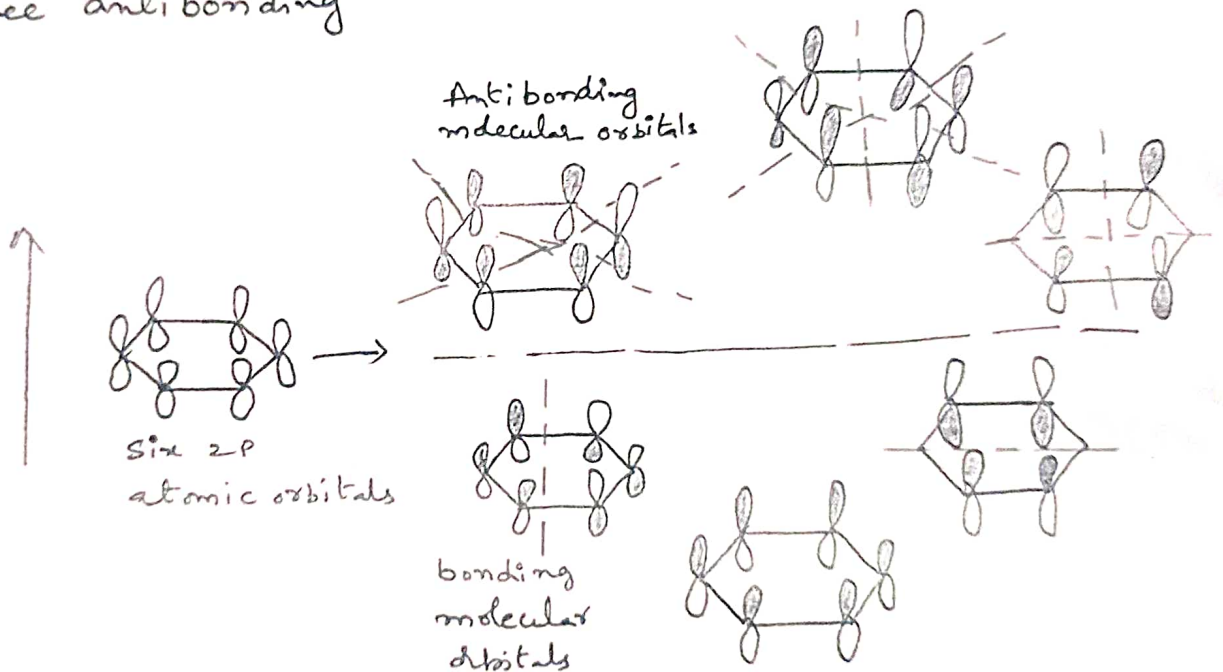

[Node: is region absolutely never find an electron]

2. π molecular orbitals of butadiene

Butadiene consists of 4 individual p orbitals, the π system of butadiene will contain 4 π molecular orbitals (containing 4 π electrons). During filling the lowest energy molecular orbitals get filled first as shown in diagram.

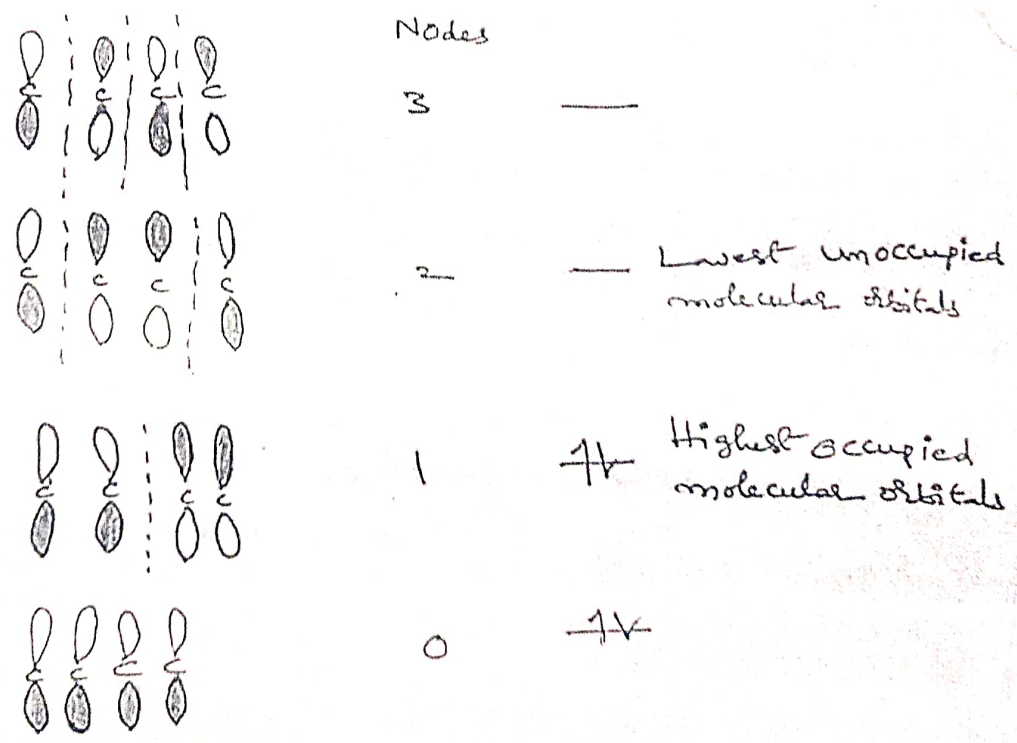
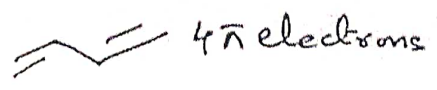

UNIT-II

Band Theory of Solids

The Concentration of atoms in a gaseous medium is low, when compare to Concentration of atoms in a solid medium. The interaction between any two atoms in gaseous substance is very weak, since the interatomic distance is large.

In case of solids, the interatomic distance between the atoms is small and there is a strong interaction between two successive atoms.

Due to this interaction, the energy levels of atoms overlap with each other and forms bands namely Valency band & Conduction band.

Valency Band: The band which is formed due to Valence electrons is known as Valence band. This band is always completely filled (or) half filled with electrons, but it is never be empty. So this is highest filled energy band.

Conduction Band: The band which is formed due to Conduction electrons is known as Conduction band. This band is always half filled (or) empty with electrons, but it is never completely filled with electrons. So this is unfilled energy band.

Band energy gap (or) forbidden energy gap: The distance between

Valency band and Conduction band is called Band energy gap

(or) forbidden energy gap.

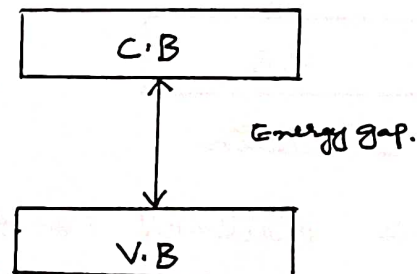

Based on energy gap, the solid materials are divided into 3 types. 1) Insulator 2) Conductor 3) Semiconductor

Insulator :- The material which do not allow electric current to pass through it is called insulator.

eg:- plastic, wood, rubber. Here the distance between valency band and conduction band is large so, electron transition from V.B to C.B must require high energy but it is not possible.

Conductor :- The material which allow electric current to pass through it is called conductor. Ex → Copper, silver, steel etc.

When a small potential difference across the material, the electron will undergo transition from V.B to C.B. The distance between V.B + C.B is very very small and conducts current in material.

Semi Conductor :- The material which allow the electric current partially to pass through it is called semi conductor. Ex → Silicon, Germanium (Ge). The distance between valency band + conduction band is very small when compare to insulator and greater when compare to conductor.

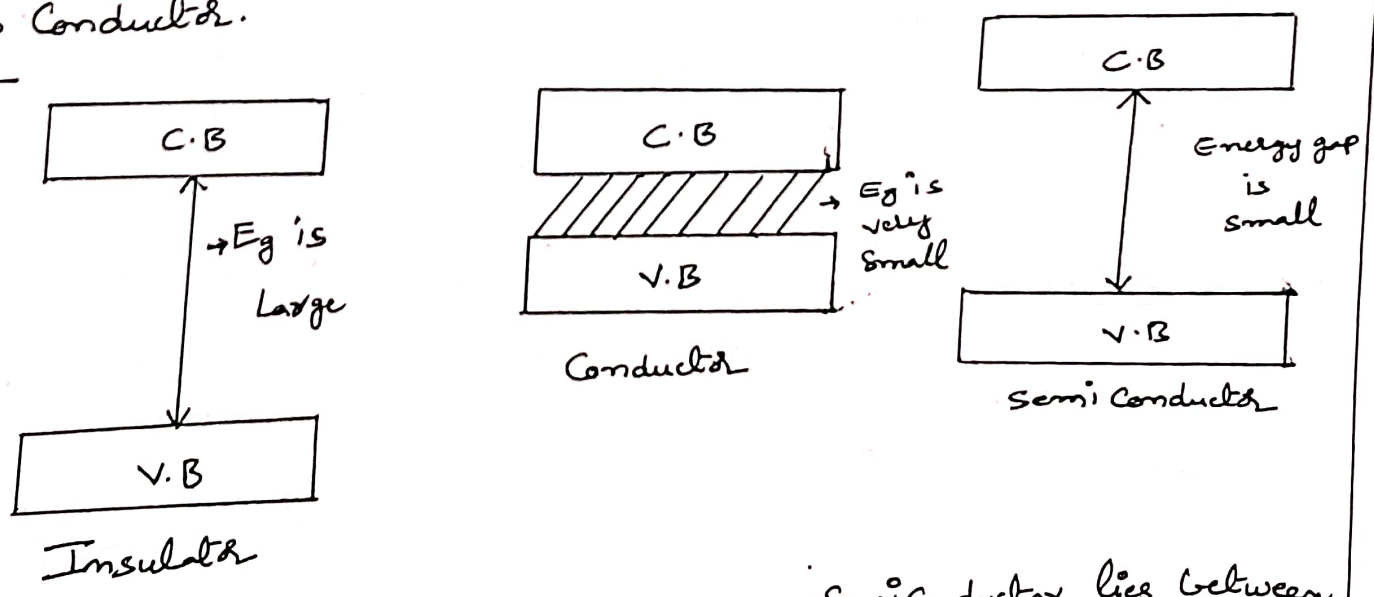

Hence electrical conductivity of a semiconductor lies between insulator & conductor.

Doping :-

The conductivity of Semiconductors is very low at room temperature. The process by which impurity is introduced in Semiconductors to enhance their conductivity is called doping.

Types of Doping:-

On the basis of impurities added for doping, Semiconductors are of two types. (1) n-type Semiconductors (2) P-type Semiconductors

1. n-type Semiconductors: (Electro-Rich impurities)

Silicon belongs to group 14 (or) IVA and have four valence electrons each. In their crystals, each atom forms four covalent bonds with its neighbours.

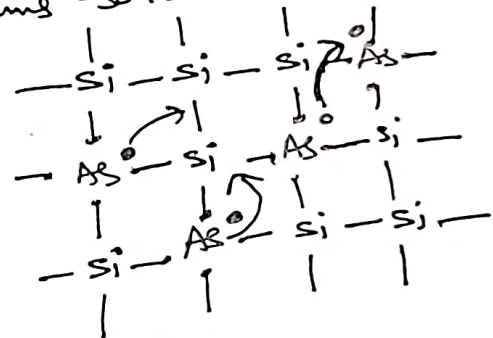
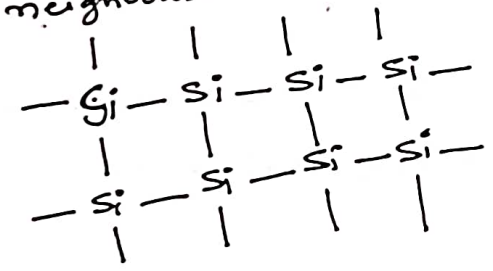

When silicon crystal is doped with a 15 group (or) VA Group element like As, which contains five valence electrons. Four out of five electrons are used in the formation of four covalent bonds with the four neighbouring silicon atoms. The fifth electron is not used in bonding thus, it is considered as extra and hence, becomes delocalised. These delocalised electrons increase the conductivity of doped silicon. Here the increase in conductivity is due to negatively charged electron, hence doped As with electron rich impurity is called n-type semiconductor.

2. P-type Semiconductor (Electron-Deficit Impurities)

When silicon is doped with a group 13 (or) III A Group element like B (or) Al, which contains only 3 valence electrons. In the place of fourth electron, a hole is created. This is called electron hole (or) electron vacancy.

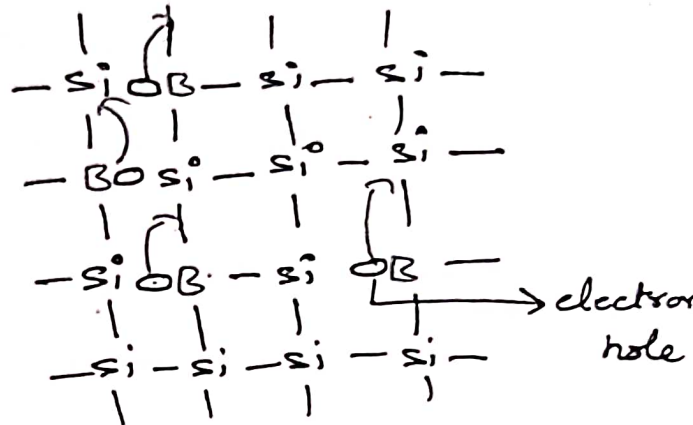
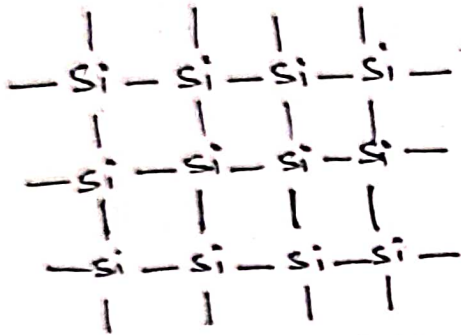

When electric field is applied the electrons move towards positively charged plate and electron holes move towards the negatively charged plate. Hence silicon doped with electron deficit impurities are called P-type semiconductors.

Superconductors :-

The phenomenon of attaining zero resistivity (or) infinite conductivity at low temperature is known as superconductivity. The material becomes a superconductor.

The temperature at which the material undergoes a transition from normal state to superconducting state is known as critical temperature (or) transition temperature (T_c).

Different materials will have different T_c values

Example:	Aluminium	$T_c = 1.19K$
	Lead	$T_c = 7.2K$
	Tin	$T_c = 0.39K$
	Tungsten	$T_c = 0.01K$

Properties of Superconductors

- 1) Superconductivity is a low-temperature phenomenon
- 2) The transition from normal state to superconducting states occur below the critical temperature.
- 3) Superconductors do not allow magnetic field through them and behave as a diamagnetic. This property of expulsion of magnetic field is known as Meissner effect.
- 4) The magnetic field at which a superconductor loses its superconductivity and becomes a normal conductor is known as critical magnetic field (H_c).
- 5) Superconductivity occur in metallic elements in which the number of valence electrons lies between 2 and 8.
- 6) Superconducting materials are not good conductors at room temperature.

Types of Superconductors

In the presence of critical magnetic field, a superconductor converts into a normal conductor. Based on the conversion process, superconductors are classified into two types.

1. Type I Superconductor
2. Type II Superconductor

1. Type-I Superconductors :- It is also known as soft superconductors. The superconductors that exhibiting a complete diamagnetic property (meissner effect) are called type I superconductors. Ex:- Al, Zn, Hg, Sn etc.

2. Type-II Superconductors :- It is also known as hard superconductors. The superconductors which allow partial magnetic flux density inside the superconductors Ex:- NiTi, Ni₃Sb, etc.

Applications:-

- 1) The Superconducting magnets are used in the nuclear magnetic resonance (NMR) and Magnetic resonance image (MRI)
- 2) These are used in manufacturing electric generators and motors.
- 3) Superconductors are used to detect the variation of ^{67}Zn content in the human body.
- 4) Superconductors are used in Magnetoencephalography.

Super Capacitors

Capacitor :- A Capacitor stores electrical charge and is capable of discharging it whenever is required. It blocks DC and allows AC to pass through it.

But the super capacitor can be charged and discharged continuously. Due to carbon technology, activated carbon is used as a physical barrier.

Super Capacitor :- A Super Capacitor is a type of capacitor that can store a large amount of energy, i.e. 10 to 100 times more energy per unit mass (or) volume compared to electrolytic capacitors.

Classification of Super Capacitors

According to different energy storage mechanisms, super capacitors can be divided into 3 types.

(a) Electrostatic Double layer Capacitors :- [EDLC's]

These EDLC's use carbon electrodes (or) derivatives with much higher capacitance.

(b) Electrochemical Pseudo Capacitors :- [ECPc's]

ECPc's use metal oxide (or) conducting polymer electrodes.

(c) Hybrid Capacitors :- [HC's]

Hybrid capacitor such as lithium-ion capacitor use electrodes with differing characteristics. One is electrostatic capacitance and the other mostly electrochemical capacitance.

Applications:-

- 1) These are used in laptop Computers.
- 2) Photographic flashes in digital camera's and LED flash lights
- 3) These are used in UPS [Uninterruptible Power Supplies].
- 4) These are used in Railways, cranes, buses, etc. in the form of Supplement batteries.

Nano Chemistry

The study of synthesis and analysis of materials in a nano scale range is known as "Nano chemistry" and this type of materials is known as "Nano materials".

Nano = one billionth part of meter.

$$1 \text{ Nano meter} = 10^{-9} \text{ m}$$

Classification of Nano materials:-

Nano materials are classified into 3 types, based on arrangement of atoms (or) molecules.

1. Materials with one dimensions in a nanoscale range.
Ex:- Thin films, Surface coating
2. Materials with two dimensions in a nanoscale range.
Ex:- Nano Carbon tubes, Nanowires, Biopolymers etc.
3. Materials with three dimensions in a nanoscale range.
Ex:- Fullerenes.

Fullerenes :-

The another form (or) allotrope of Carbon is known as Fullerene [C₆₀]. It was discovered by Surl, Kroto and Smalley.

The structure of fullerene is bucky ball (or) foot ball structure. It undergoes sp² hybridization.

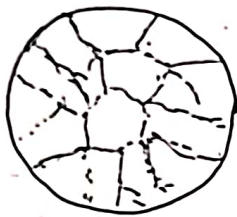

Preparation method :- Fullerenes are prepared from "Graphite rods" (or) Graphite electrodes.

Graphite rods undergo vapourisation process in the presence of inert atmosphere (He) by applying of high electric current produces Fullerenes.

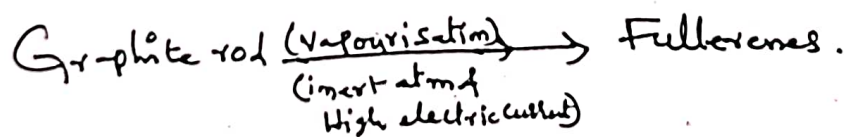

Properties :-

- 1) Fullerenes are soluble in Toluene and Carbon disulphide (CS₂)
- 2) It is fine black powder
- 3) Fullerenes are poor electrical conductors, but mixing with conducting materials these act as high electrical conductors.
- 4) It is unstable at higher temperature.

Applications of Fullerenes :-

- 1) Fullerenes are the best anti-oxidants
- 2) Fullerenes are used in microelectronics
- 3) They are used in microelectronics
- 4) used as optical devices
- 5) used as Superconductors
- 6) used as fillers.

Carbon Nano Tubes :- CNT's

Carbon nano tubes are another form of Carbon. It has cylindrical structure. In this structure Carbon undergoes sp^2 hybridization similar to graphite.

Carbon nano tubes are classified into two types.

- (i) Single wall Carbon tubes
- (ii) Multi-wall Carbon tubes.

Properties :-

1. Nano tubes are stiff and strong fibres (604 Pa).
2. CNT's are also act as semi conductivity and metallic conductivity nature.
3. CNT's Carbon undergoes sp^2 hybridization.

Applications :-

1. Switching Components in Computer.
2. CNT's used as storage device in battery
3. CNT's also used in field emission light devices.
4. They are used as solid lubricants
5. CNT's are used as needles to a therapy against Cancer.

Graphene nanoparticles

Graphene (or) Graphene :- Graphene is the allotrope of Carbon consisting of a single layer of atoms arranged in a two-dimensional lattice.

Preparation :-

Ultrasonication of DMF (dimethyl formamide) and water 9:1 mixture used and produced single layer graphene.

(or)
Oxidation of graphite with strong oxidizing agents such as KMnO_4 + NaNO_3 in H_2SO_4 can ~~produce~~ prepare Graphene.

Properties :-

- 1) High thermal conductivity
- 2) High Electrical conductivity
- 3) High elasticity and flexibility

Applications :-

- 1) These are used in Batteries

- 2) Graphene are used in sensors.
- 3) These are used as Energy generators
- 4) Graphenes used in mobile devices
- 5) These are used as anti-corrosion coating and paints etc.
- 6) Graphene also used in water filters, supercapacitors etc.

UNIT-III

ELECTROCHEMISTRY

Introduction

Electrochemistry is a branch of chemistry, which deals with the chemical applications of electricity. Electrochemistry deals with the chemical reactions produced by passing electric current through an electrolyte (or) the production of electric current through chemical reactions.

Cell Terminology:-

Current: Current is the flow of electrons through a wire (or) any conductor.

Electrode: Electrode is a material (or) a metallic rod/bar/strip which conducts electrons.

Anode: Anode is the electrode at which oxidation occurs.

Cathode: Cathode is the electrode at which reduction occurs.

Electrolyte: Electrolyte is a water soluble substance forming ions in solution, and conduct electric current.

Anode Compartment: It is the compartment of the cell in which oxidation half-reactions occurs. It contains the anode.

Cathode Compartment: It contains the cathode. It is the compartment of the cell in which reduction half-reaction occurs.

Half-cell: Half cell is a part of cell, containing electrode and electrolytic solution. If oxidation occurs at the electrode that is called oxidation half cell. If reduction occurs at the electrode that is called reduction half cell.

Reference Electrodes

(i) Calomel Electrode :-

It is a secondary electrode, consists of a glass tube having a side tube on each side as shown in figure. Mercury of degree of purity is placed at the bottom of this tube and is connected to the other circuit by means of platinum wire sealed in a glass tube.

The surface of mercury covered with paste of Hg_2Cl_2 and mercury in KCl solution.

The electrode is connected with the help of side tube on the left through a salt bridge with the other electrode, the potential of which is to be determined.

The potential of Calomel electrode depends upon the concentration of the potassium chloride (KCl) solution.

The electrode reaction when the electrode acts as cathode is:

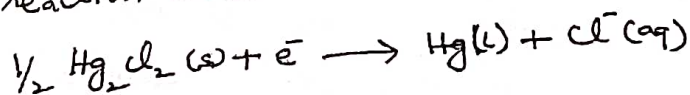

(ii) Silver - silver chloride (Ag-AgCl) Electrode :-

This is another widely used reference electrode. It is reversible and stable and can be combined with cell containing chlorides without inserting liquid junctions. Its standard electrode potential with respect to the standard hydrogen electrode is 0.2224V at 298K.

The electrode is represented as: $Ag/AgCl/Cl^-$

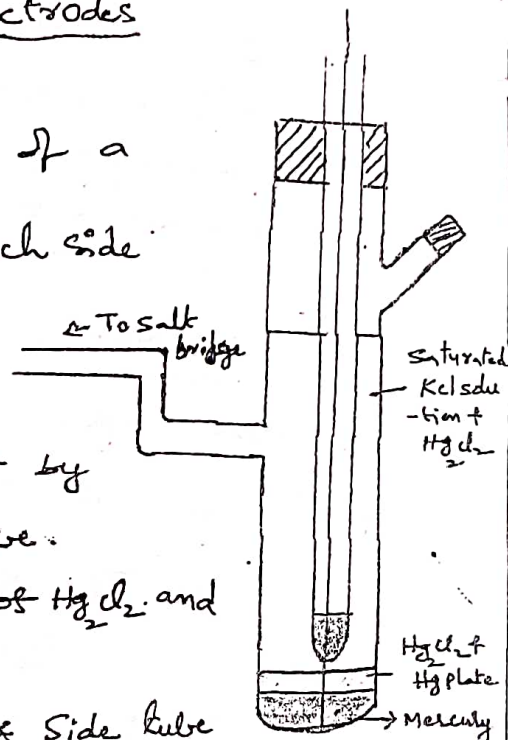
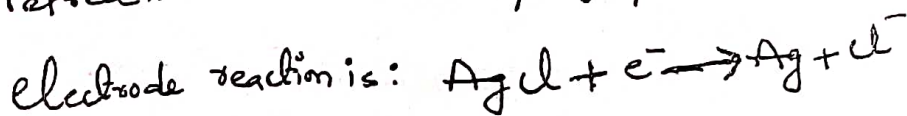

Glass Electrode:

A glass electrode is made with a thin membrane of pH sensitive glass. This electrode consists of long glass tube with a thin walled glass bulb at one end. This glass can specifically sense hydrogen ions up to a pH about 9. The bulb contains 0.1M HCl and a Ag/AgCl electrode is immersed into the solution and connected by a platinum wire for electrical contact.

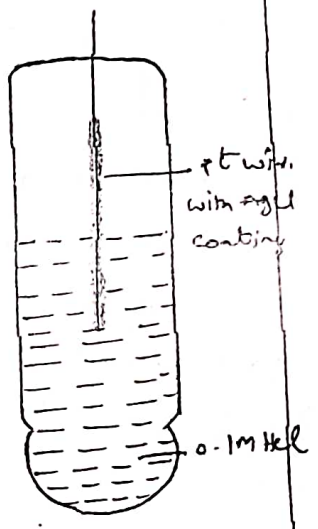

The electrode is represented as, $Ag/AgCl(s), HCl(0.1M)/glass$.

Advantages :- (i) Glass electrode can be employed in the presence of

strong oxidizing (or) reducing substances and metal ions.

(ii) It is not poisoned easily.

(iii) Accurate results are obtained between pH range 1-9

(iv) It is simple to operate, can be portable to anywhere easily.

Limitations :- (i) It does not function properly in some organic

solvents like pure alcohol.

Nernst Equation (for electrode potential)



Consider the following redox reaction

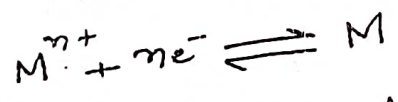

For such a redox reversible reaction, the free energy change (ΔG) and its equilibrium constant (K) are inter related

$$\Delta G = -RT \ln K + RT \ln \frac{[Product]}{[Reactant]}$$

as

$$= \Delta G^\circ + RT \ln \frac{[\text{Products}]}{[\text{Reactants}]} \quad \text{--- (1)}$$

Where

ΔG° = standard free energy change

The above equation (1) is known as Van't Hoff Isotherm.

The ~~decrease~~ decrease in free energy ($-\Delta G$) in the above reaction will produce electrical energy. In the cell, if the reaction involves transfer of 'n' number of electrons, then 'n' faraday of electricity will flow. If 'E' is the emf of the cell, then the total electrical energy (nEF) produced in the cell is

$$-\Delta G = nEF \quad \text{or} \quad -\Delta G^\circ = nE^\circ F \quad \text{--- (2)}$$

Comparing equation (1) and (2), it becomes

$$-nEF = -nE^\circ F + RT \ln \frac{[M]}{[M^{n+}]} \quad \text{--- (3)}$$

Dividing the above equation (3) by $-nF$

$$E = E^\circ - \frac{RT}{nF} \ln \frac{1}{[M^{n+}]}$$

\therefore activity of solid metal $[M] = 1$

In general,
$$E = E^\circ - \frac{RT}{nF} \ln \frac{[\text{Product}]}{[\text{Reactant}]}$$

(or)

$$E = E^\circ + \frac{RT}{nF} \ln [M^{n+}]$$

(or)

$$E = E^\circ + \frac{2.303RT}{nF} \log [M^{n+}] \rightarrow (4)$$

When, $R = 8.314 \text{ J/mole}$

$F = 96500 \text{ Coulombs}$

$T = 298 \text{ K } (25^\circ \text{C})$

Then equation becomes

$$E = E^\circ + \frac{0.0591}{n} \log [M^{n+}] \rightarrow (5)$$

In general =
$$E = E^\circ_{\text{Red}} + \frac{0.0591}{n} \log C$$

For oxidation potential =
$$E = E^\circ_{\text{Oxi}} - \frac{0.0591}{n} \log [M^{n+}] \rightarrow (6)$$

The above equation 5 & 6 are known as "Nernst Equation for single electrode potential".

Cell Potential (or) EMF (Electromotive force)

Electromotive force (or) Cell potential is defined as "The potential difference between two electrodes of a cell"

$$EMF \text{ of a cell} = \text{Standard reduction potential of right hand side} - \text{Standard reduction potential of left hand side electrode}$$

$$E_{cell}^{\circ} = E_{right}^{\circ} - E_{left}^{\circ} \text{ (or) } E_{R.H.S}^{\circ} - E_{L.H.S}^{\circ}$$

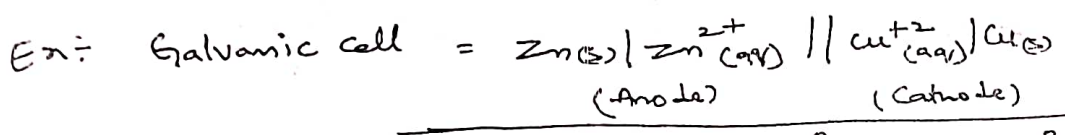

$$E_{cell}^{\circ} = E_{Cu^{2+}/Cu}^{\circ} - E_{Zn/Zn^{2+}}^{\circ} \text{ (or) } E_{Cathode}^{\circ} - E_{Anode}^{\circ}$$

Calculation of Cell Potential :-

Calculation of cell potential at standard conditions at 1M concentration and 1atm pressure at 25°C is carried out under the following steps.

Procedure: Step 1 :- Write the oxidation and reduction half-reactions for the cell

Step 2 :- Look up the reduction potential $[E_{red}^{\circ}]$ for the reduction half reaction.

Step 3 :- Look up the reduction potential (or) oxidation potential for the oxidation half reaction. The oxidation potential = $E_{oxi}^{\circ} = -E_{red}^{\circ}$

Step 4 :- Add the two half-cell potentials to get the overall cell standard cell potential $\Rightarrow E_{cell}^{\circ} = E_{Cathode}^{\circ} - E_{Anode}^{\circ}$
 $E_{cell}^{\circ} = E_{reduction}^{\circ} - E_{oxidation}^{\circ}$

$$\Rightarrow \text{only for Cell Potential} = E_{cell} = E_{red} + [E_{oxi}] \text{ (or) } E_{cell} = E_{red} - E_{red} \\ = E_{Cathode} - E_{Anode} \text{ (or) } E_{Anode} + E_{Cathode}$$

POTENTIOMETRIC TITRATIONS

Potentiometric titrations are those titrations which involves the measurement of electrode potentials with the addition of titrant for the determination of equivalence (or) end point so that substance can be estimated quantitatively.

These are powerful and comfortable analytical methods for a wide range of applications.

- (a) They are more accurate and precise
- (b) Can be used for colored, turbid or fluorescent analyte solution
- (c) Can be used in the titration of mixture of acids, mixture of bases or mixture of halides.
- (d) Can be used if there is no suitable indicator or colour change is difficult to ascertain.

Types of Potentiometric titrations:

Potentiometric titrations can be classified into the following

① Acid-base titrations ② Redox titrations ③ Precipitation titrations

Redox Titrations

For any redox reaction: $aA + bB \rightarrow cC + dD$

The potential is given by Nernst equation

$$E = E^{\circ} + \frac{0.0591}{n} \log \frac{[\text{Oxi}]}{[\text{Red}]}$$

E° is the standard potential of the cell. The potential of the system is controlled by the ratio of the concentration of the oxidized to the reduced species present.

Redox titration between Fe^{2+} and dichromate ions

When a solution of Ferrous ion is titrated with a solution of potassium dichromate, the following redox reaction takes place.

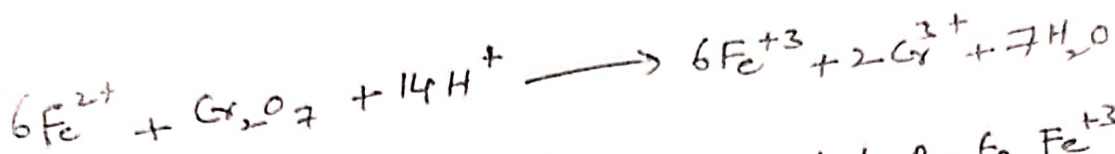

During this titration Fe^{2+} is converted into Fe^{3+} . At the equivalence point, there will be a sharp change due to sudden removal of all Fe^{2+} ions.

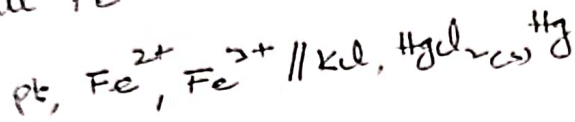

A graph between EMF measured against the volume of potassium dichromate added is drawn and the equivalence point is noted from the graph

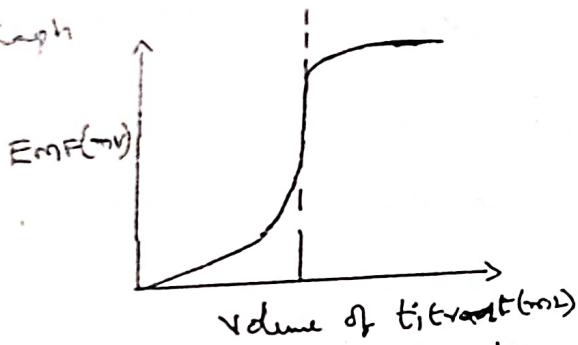

(a) Potentiometric titration curve

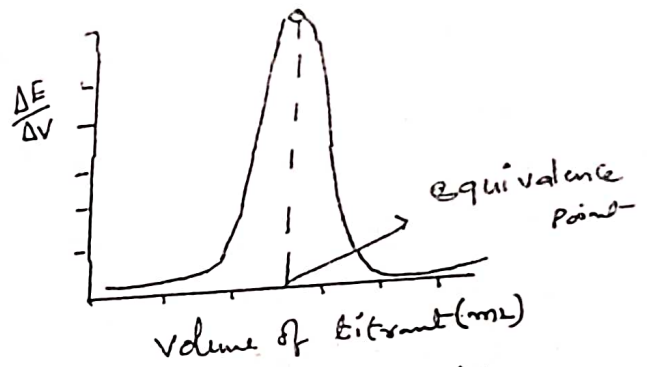

(b) First derivative plot

Conductivity

Conductivity is the ability to carry current. It is the reciprocal of resistivity.

Resistance (R):-

The resistance of a conductor is directly proportional to its length and inversely proportional to its area.

$$\Rightarrow R \propto \frac{l}{A} \Rightarrow R = S \times \frac{l}{A}$$

R = Resistance in ohms
l = length in cm
A = Area in cm²
S = Specific resistance

Conductance (C) Conductivity of the cell:-

The reciprocal of resistance is known as Conductance and this property is known as Conductivity of the cell.

$$C \propto \frac{1}{R} \Rightarrow C \propto \frac{1}{S} \times \frac{1}{(l/A)}$$

$$\therefore C = K \times \frac{A}{l} \text{ ohm}^{-1}$$

C = Conductance
K = Specific Conductance

Specific Conductivity:-

The reciprocal of specific resistance of an electrolytic solution is known as specific conductivity

$$K = \frac{1}{S} = \left(\frac{l}{A}\right) R \text{ or } C \times \frac{l}{A} \text{ ohm}^{-1} \text{ cm}^{-1}$$

Molar Conductivity (Λ_m):-

The conductance of all the ions present in one mole of electrolyte in the solution.

$$\Lambda_m = \frac{1000 \times K}{M} = \text{ohm}^{-1} \text{ cm}^2 \text{ mol}^{-1}$$

Equivalent Conductivity:-

The conductance of all the ions present in one equivalent of the electrolyte in the solution.

$$\Lambda_{eq} = \frac{1000 \times K}{N} \text{ ohm}^{-1} \text{ cm}^2 \text{ eq}^{-1}$$

Conductivity cell:-

Conductivity is the measurement of the electrolytes in a solution. It is defined as the conductance in a given volume of sample.

$$\therefore \text{Conductivity of the cell} = \text{Conductance} \times \text{Cell Constant} \\ = \frac{\text{Electrical current}}{\text{Voltage}} \times \frac{\text{Distance}}{\text{Area}}$$

The conductivity is measured by using a cell is known as conductivity cell.

Cell Constant:- Cell Constant is of particular cell is determined as the ratio of the distance between the two electrodes of the cell to the area of the electrodes.

$$\boxed{\text{Cell Constant } (\alpha) = \frac{l}{A} = \frac{\text{cm}}{\text{cm}^2} = \text{cm}^{-1}}$$

Relationship between Conductivity and Cell Constant:-

Conductivity is the ability of a solution to pass an electric current and it is related to Cell Constant by following equation

$$\text{Specific Conductivity } (K) = \text{Conductance} \times \text{Cell Constant}$$

$$K = C \times \frac{l}{A}$$

$$\frac{l}{A} = \frac{K}{C} \Rightarrow \boxed{\alpha = \frac{K}{C}}$$

$$\therefore \text{Cell Constant} = \frac{\text{Specific Conductivity}}{\text{Conductance}}$$

Conductometric Titrations:-

The determination of the end point of a titration with the help of conductivity measurements is termed as 'conductometric titrations'. The principle involved is that 'electrical conductance depends up on the number and mobility of ions'.

Types of Conductometric Titrations:- Conductometric titrations are

- (i) acid-alkali titrations
- (ii) Redox titrations
- (iii) Precipitation titrations
- (iv) Redox titrations
- (v) Complexometric titrations.

(i) Acid-Base Titrations

(a) Strong Acid-Strong Base Titration (HCl vs NaOH) :

Consider the titration of a strong acid (HCl) with strong base (NaOH)

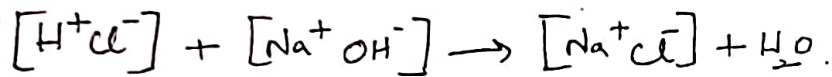

The acid solution has high conductivity due to high mobile hydrogen ions. As alkali is added gradually, the hydrogen ions (H^+) are replaced by slowly Na^+ ions as represented above.

Thus conductance of the solution decreases until all the acid has been neutralized and equivalence point has reached.

Further addition of alkali raises the conductance sharply, as there is an excess of hydroxide ions.

A graph is plotted between the volume of NaOH and the conductance of solution. The exact equivalence point is intersection of the two straight lines.

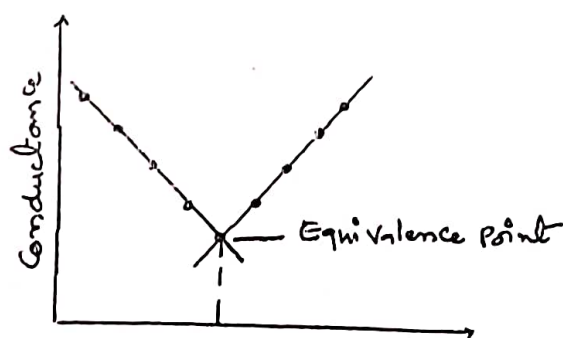

(b) Strong acid with a weak base: (HCl vs NH_4OH)

When ammonium hydroxide is added to HCl, the conductivity decreases because of the replacement of the fast moving H^+ ions by slow moving NH_4^+ ions.

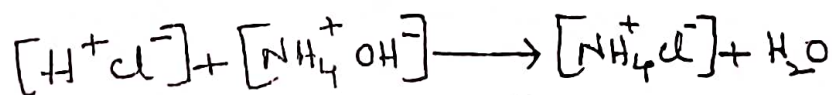

7

After the end point does not change the conductance because NH_4OH is a weakly ionised electrolyte and very small conductivity compared with acid or its salt.

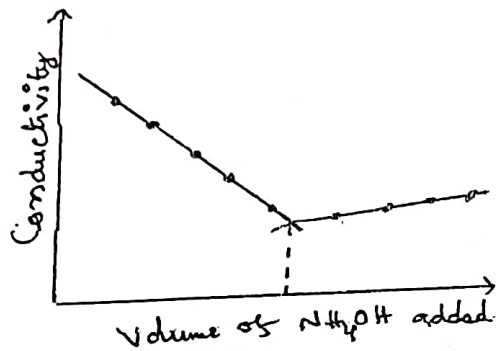

© Weak acid with a strong base: (CH_3COOH vs. NaOH)

The conductance of the acid will be low because of its poor dissociation. When a small amount of NaOH is added to CH_3COOH , the conductivity decreases initially then increases with the further addition of NaOH .

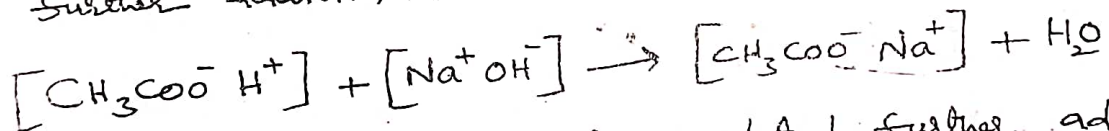

When the neutralisation of acid is completed, further addition of alkali produces excess OH^- ions. The conductance of solution therefore begins increasing more rapidly.

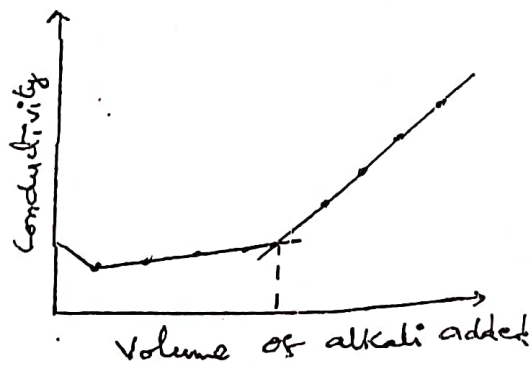

ELECTROCHEMICAL SENSORS

Sensor: sensor is a device which is able to detect a change in physical/chemical quantity and produce an electrical signal suitable for a computer.

Electrochemical Sensors: Electrochemical sensors are one of the broadest and oldest types of sensors. These are particularly useful for the analysis of inorganics in complex aqueous matrices and to detect oxygen and toxic gases.

Schematic Representation of Electrochemical Sensor

The electrochemical sensor mainly consists of outer frame containing an electrolyte gel and three electrodes. At the top of the frame it should have gas permeable membrane. The electrodes are carefully constructed with high sensitivity, long life and allow large surface area. Each cell shall construct with special filter electrodes and electrolytes for high specificity. This will help for allowing of larger signal, immediate response and even a smaller volume of electrolyte will provide same response.

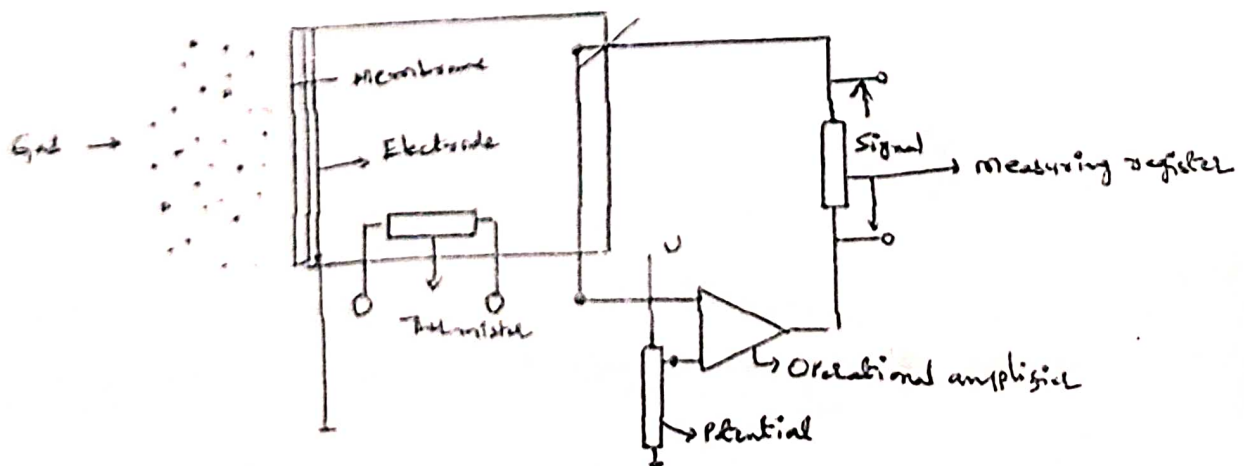

Applications :- (i) To detect oxygen and toxic gases

- (ii) To monitor Waste steam discharge
- (iii) To monitor Pollutants in an environment
- (iv) To monitor Continuously levels of oils, lubricants & gas.
- (v) To monitor blood Samples
- (vi) To monitor Corrosion process, chemical parameters, inner eye lid etc.
- (vii) To monitor the ionic Concentration of pesticides, insecticides, fertilizers, pharmaceutical drugs, etc.

Classification of Electrochemical sensor :

According to the measured electrical parameter, Electrochemical sensors divided into three kinds. They are (i) Potentiometric sensor (ii) Amperometric sensors (iii) Chemiresistors (iv) Conductometric sensors

Potentiometric Sensors :

A potentiometric sensor is a type of chemical sensor that may be used to determine the analytical concentration of some components of the analyte gas (or) solution. These sensors measure the electrical potential of an electrode when no current is present.

Working principle of Potentiometric Sensors :-

The signal of a general Potentiometric sensor is based on the Nernst equation. This equation predicts a linear dependence of the sensor response.

$$E = E^{\circ} + \frac{RT}{nF} \ln [a_i]$$

- E = Potential
- R = Gas Coefficient
- F = Faraday constant
- n = number of electrons
- E° = standard potential
- a_i = activity of the particular ion

The signal is measured as the potential difference (voltage) between the working electrode and potential reference electrode.

The working electrode's potential must depend on the concentration of the analyte in the gas (or) solution phase.

In this type of sensors Ion selective Electrodes [ISE] are plays an important role for measuring potential (EMF) based on the concentration of electrolytic solution in a given samples.

Applications :- These are mainly used in measurement of glucose in blood and urine.

Ampereometric Sensors (Voltammetric Sensors):

In this type of sensors we measure current in Amperes.

The principle of Ampereometric is the measurement of the current between the measuring and counter electrode and gives signal with respect to the current.

- Applications :-
- (i) These are used in Food Industries
 - (ii) These are used to determine the amount of uric acid in urine
 - (iii) It is used for measuring the quality of water, i.e. measuring the quantity of dissolved oxygen presence in given water samples.

Battery (or) Cells

A Cell :- Contains only one anode and Cathode

A Battery :- Contains several anode and Cathode

Types of Battery :-

1. Primary Battery (or) Primary cells :- [Non-Rechargeable Battery]

These cells are not designed to be recharged (or) electrode reactions cannot be reversed by passing external electrical energy. Therefore these are used only once, after they become dry (or) dead.

Ex:- Zinc-Air Battery

Zinc-Air Battery :-

Zinc-Air Battery is an example of non-rechargeable battery and also called metal-Air Battery

Construction :- Granulated zinc and with an electrolyte KOH to form a porous anode. Porous graphite acts as a Cathode.

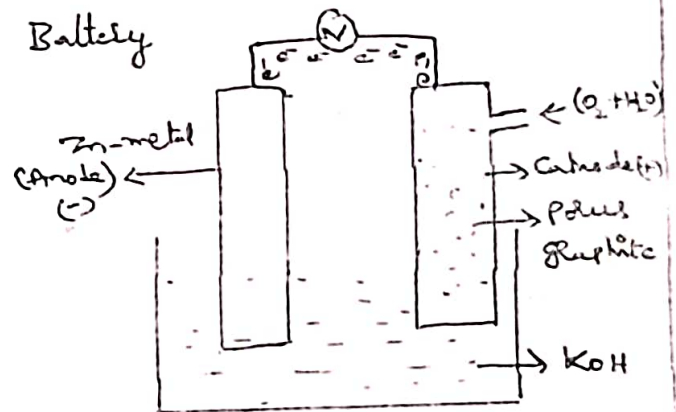

Working :- At anode oxidation takes place in the zinc electrode by the liberation of electrons. These are transmitted to cathode. At cathode reduction takes place in the porous nature of electrode by passing of air $[O_2 + H_2O]$

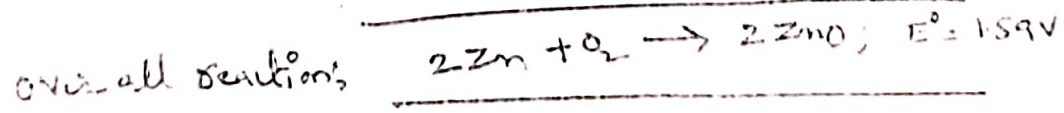
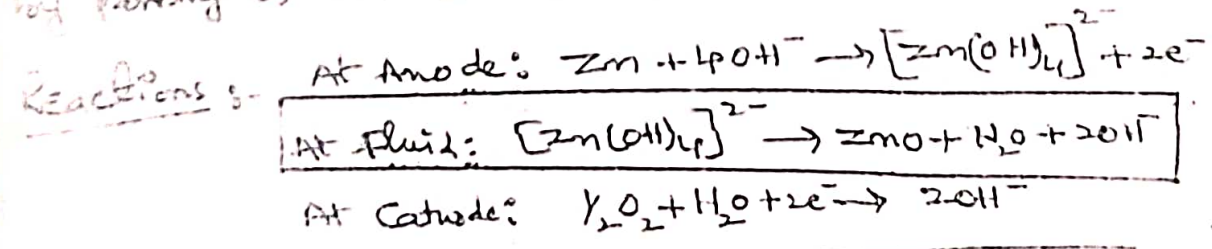

465
10x
527
1357-13

Fuel Cells

Definition:- Fuel cell is a voltaic cell, which converts the chemical energy of the fuels directly into electricity without combustion.

Ex:- (1) Hydrogen-oxygen fuel cell (2) methanol-oxygen fuel cell

1) Hydrogen-oxygen fuel cell (H₂-O₂ fuel cell):-

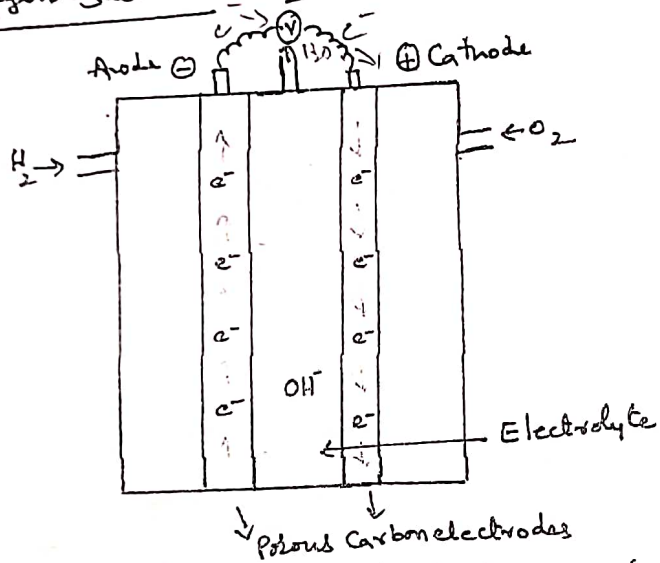

10x
560
670
1330

The cell consists of two porous electrodes anode and cathode. These electrodes are made of graphite (compressed carbon) with small amount of Pt (or) Ag catalyst. In between the two electrodes an electrolytic solution such as KOH (or) NaOH is filled. The two electrodes are connected through the voltmeter.

Working:- The fuel hydrogen is passed through the anode compartment, where it is oxidised, the oxidant (oxygen) is passed through the cathode compartment where it is reduced.

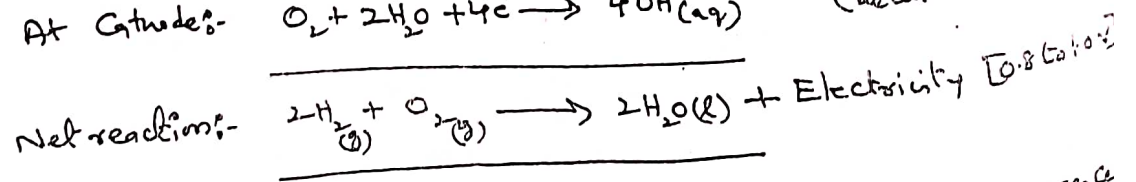
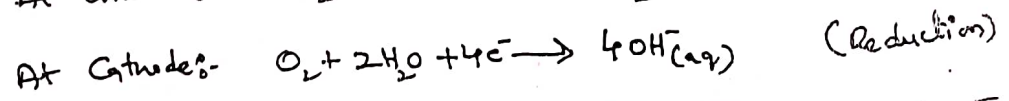
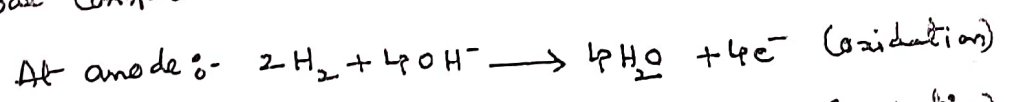

Applications:- (i) These are used as auxiliary energy source in space vehicles, military vehicles, submarines etc.

(ii) In H₂-O₂ fuel cells, the product of water is proved to be a source of fresh water for astronauts.

1) Methanol - oxygen Fuel Cell :-

Methanol - oxygen fuel cell is another important fuel cell. It is also called proton - exchange fuel cell.

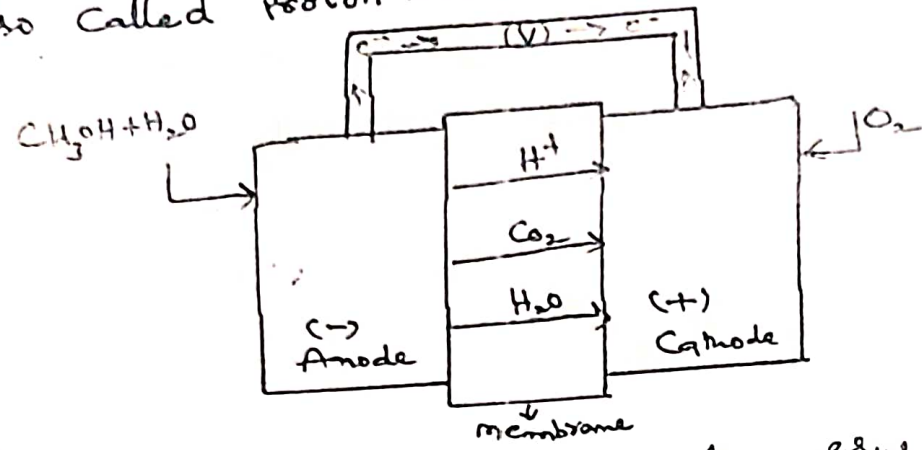

Description :- The cell consists of two porous electrodes anode and cathode. These electrodes are made of Nickel with small amount of Pt (or) Ag catalyst. These two electrodes are linked by one membrane (Nafion). These two electrodes are connected through the voltmeter.

Working :- The fuel methanol mixed with water and passed through the anode compartment where it is oxidized. The oxygen is passed through the cathode compartment, where it is reduced.

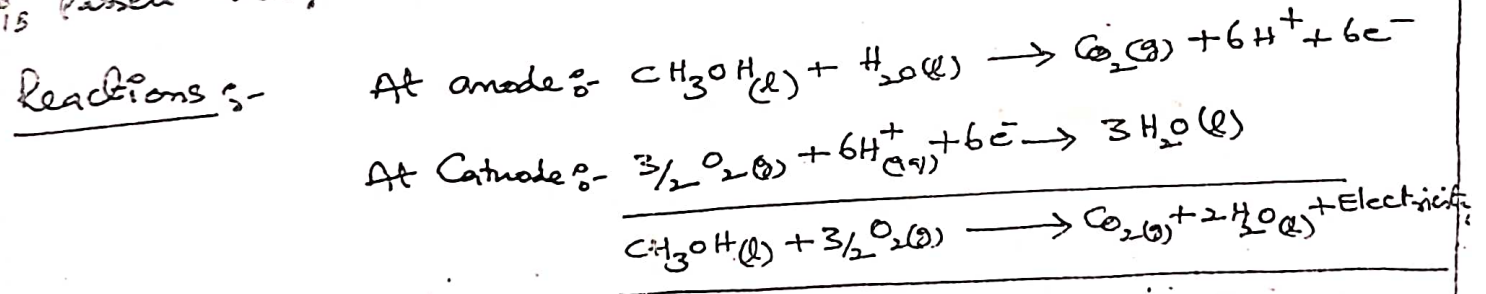

The emf of this cell is 1.21 Volts

Applications :-

- i) Storage of methanol is much easier than H_2 gas
- ii) The energy density of methanol (the amount of energy contained in a given volume) is greater than H_2 gas.

Secondary Cell (or) Battery

In Secondary batteries, the chemical reactions are reversed by passing direct electric current in opposite direction. The cells are designed for repeated use and they are able to be recharged.

Nickel-Cadmium Cell ✓

The Nickel-Cadmium cell (or) Ni-Cad battery is a secondary cell that produces a potential of about 1.4V which is slightly lower than that of Zn-carbon cell.

It consists of Cadmium anode and a cathode of a paste of Ni(OH)_2 . The electrode reactions in the cell during discharge are

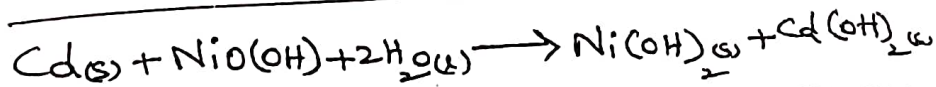
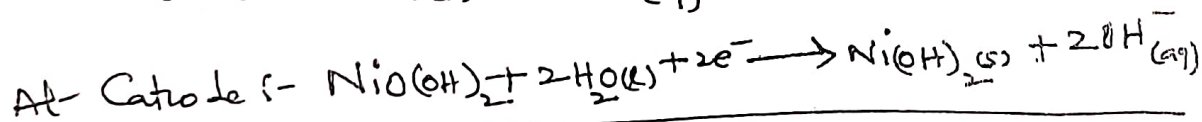
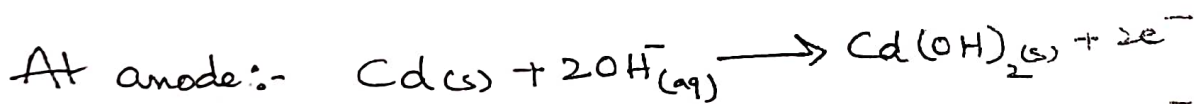

The cell reactions can be readily reversed since the reaction products Ni(OH)_2 and Cd(OH)_2 adhere to the electrode surface.

Application :- This battery used in (i) portable power tools
(ii) flash lights
(iii) CD players
(iv) electronic calculators
(v) electronic cars
(vi) cordless electronic shavers

Recharging the Battery:- The cell can be charged by passing electric current in the opposite direction.

The net reaction during charging is

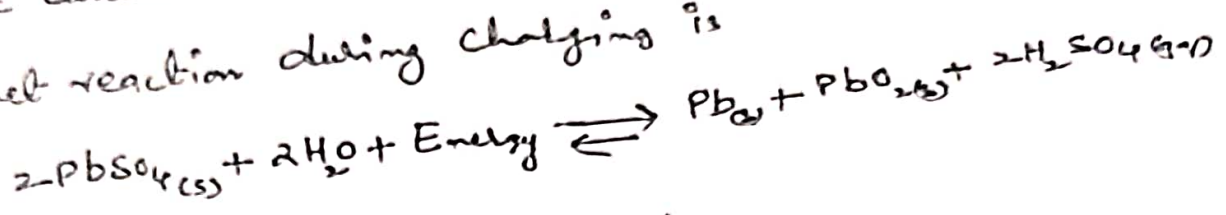

Advantages:- (i) It is made easily
(ii) It produces very high current
(iii) It also acts effectively at low temperature

Disadvantages:- (i) Recycling of this battery causes environmental hazards (ii) mechanical strain and normal bumping reduces battery capacity.

Uses:- (i) Lead storage cell is used to supply current mainly in automobiles such as cars, buses, trucks etc.
(ii) These are also used in telephone exchanges, hospitals, power stations etc.

Lithium-ion batteries (or) Lithium-ion cell

The movement of Lithium ions are reversible for charging & discharging.

Construction:- The positive electrode is typically made from a layer of chemical compound called Lithium-cobalt oxide (LiCoO_2). The negative electrode is made from layers of porous carbon (graphite). Both the electrodes are dipped in a polymer gel electrolyte and separated by a separator, which allows the Li^+ ions to pass through.

Working: (i) Charging:- During charging Li^+ ions flow from the positive electrode (LiCoO_2) to the negative electrode (graphite) through the electrolyte.

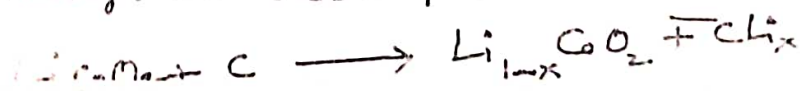

Discharging:-

During discharging, the Li^+ ions flow back through the electrolyte from negative electrode to the positive electrode. Electrons flow from the negative electrode to the positive electrode. The Li^+ ions and electrons combine at the positive electrode and deposit there as Li.

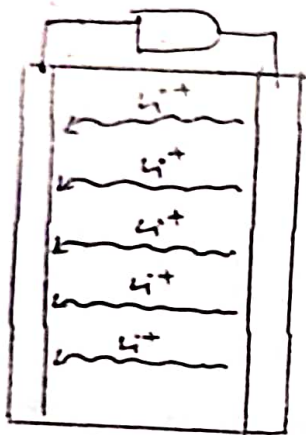
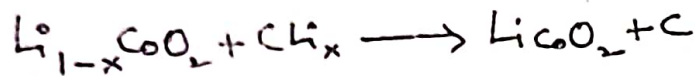

Graphite

LiCoO₂

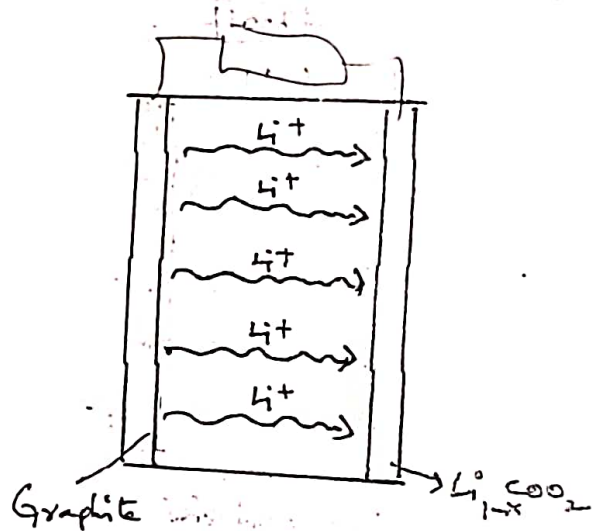

- Advantages:-
- (i) These are high voltage and light weight batteries
 - (ii) These are smaller in size
 - (iii) These produce high voltage than Ni-Cd batteries

- Uses:-
- (i) The Lithium ion batteries are used in cell phones.
 - (ii) These are used in laptops.
 - (iii) These are used in electric vehicles etc.

UNIT-IV

POLYMERS

Definition: Polymers are macro molecules (giant molecule (or) High molecular weight compound) made by linking a large number of small molecules.

Ex:

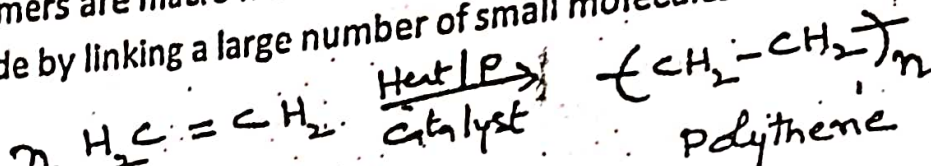

Ethylene

polythene

Poly = Many Mer = Parts

The repeating units of a polymer are called monomers.

Polymerisation: The reaction by which monomer units combine to form polymers is termed as polymerization.

Degree of polymerization: The number of repeating units in a chain is known as "Degree of Polymerisation".

Nomenclature of Polymer

a) Homo polymer: Polymer made out of same (or) identical monomer units are known as homo polymer.

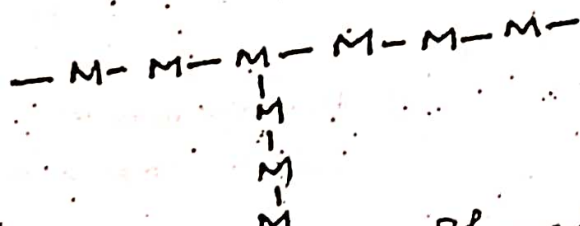
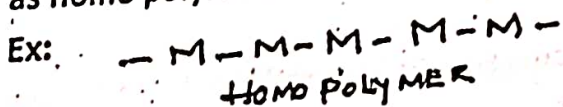

(Branched Homo Polymer)

b) Hetero polymer: Polymers are made from different types of monomers are hetero polymer (or) Co-Polymer.

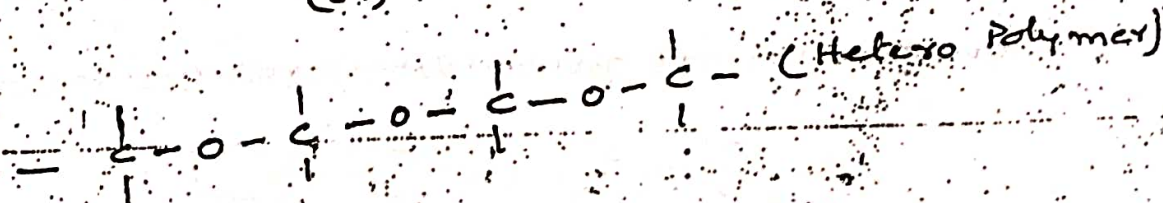
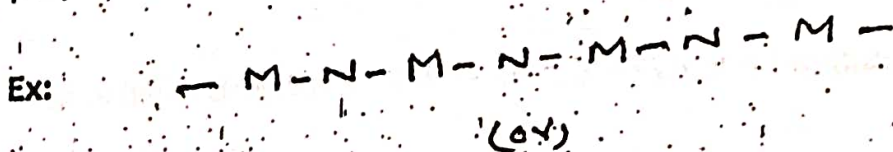

Tacticity: It is the Orientation (or) arrangement of functional groups in polymer in an orderly (or) disorderly manner with respect to main chain is called tacticity.

There are mainly three kinds of tacticity.

a) **Isotactic polymer:** If the functional groups are arranged on the same side of the chain. It is called isotactic polymer.

Ex:

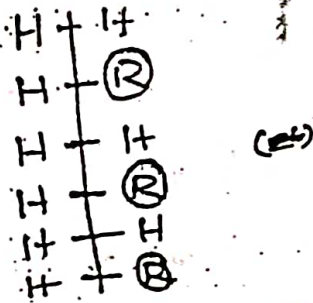

b) **Syndiotactic polymer:** If the functional groups are arranged in alternative fashion in the main chain. It is called syndiotactic polymer.

Ex:

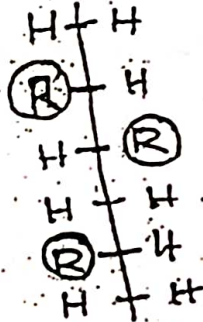

c) **Atactic polymer:** If the functional groups are arranged at random around the chain. It is called atactic polymer.



Functionality: The number of bonding sites present in a monomer is called as its functionality.

Every monomer must have minimum two bonding sites for polymerization process.

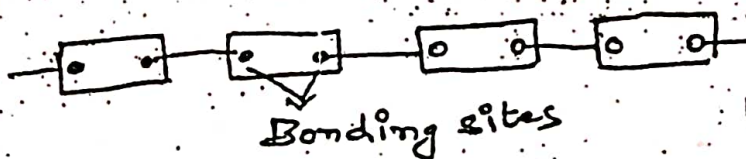

Polymerisation:

The process (or) chemical reaction by which the no. of small molecules to form a big polymer is called polymerization.

Monomer :-

Monomer is a micro molecule (small molecule) which combines with each other to form a polymer.

Functionality :-

The number of bonding sites (or) reactive sites (or) functional groups, present in a monomer is known as its functionality.

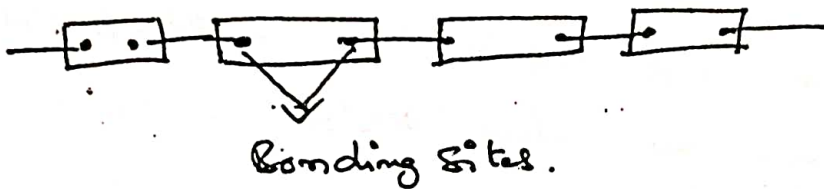

Bi-functional monomers :-

Bi-functional monomers mainly form linear (or) straight chain polymer.

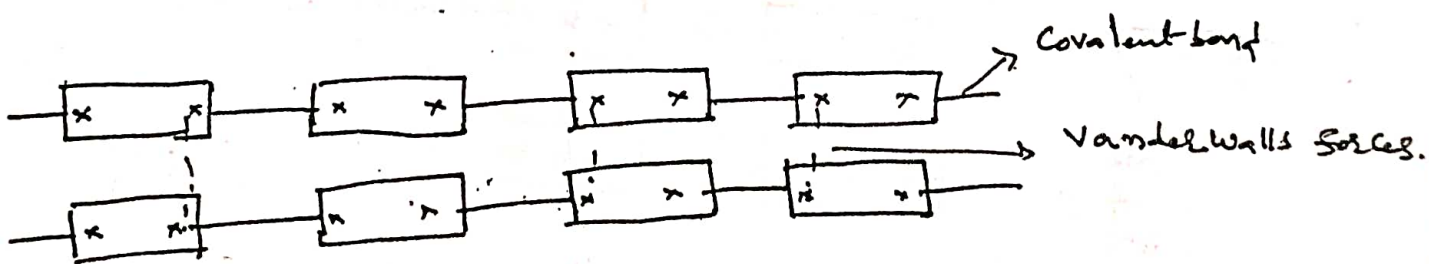

Mixed functional monomers :-

When a tri-functional monomer is mixed in small amounts with a bi-functional monomer, they form branched chain polymer.

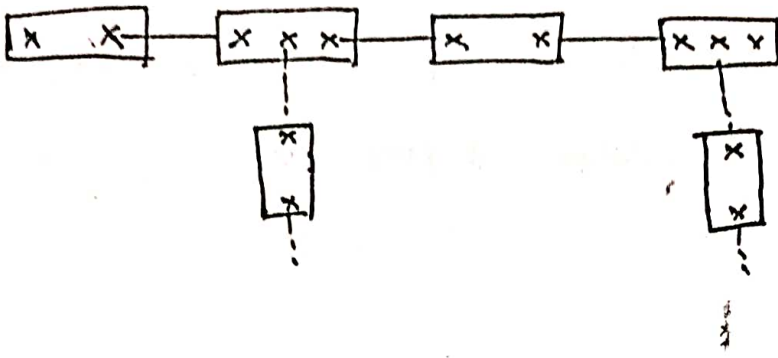

3. Poly functional monomers :

poly functional monomers form cross-linked polymer. (Three-dimensional network polymer). All the monomers in the polymer are connected to each other by strong covalent bonds. This type of polymers are hard and brittle and possess very high strength and heat resistance and also insoluble in almost all organic solvents.

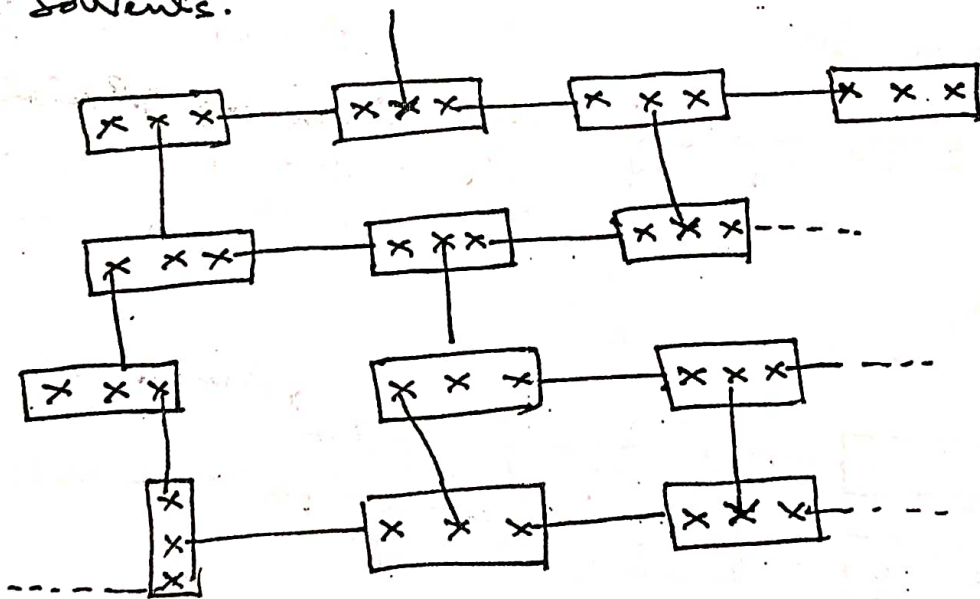

Polymerisation :- ↘

The process (or) chemical reaction by which the no. of small molecules to form a big polymer is called polymerisation.

Types of polymerization: (i) Addition polymerization (ii) Condensation polymerization (iii) Co-polymerisation.

Addition polymerization (or) chain polymerization:

This type of polymerization several bi functional monomers combine to form polymer by addition reaction with out elimination of any byproduct.

Ex: (i) Polymerisation of ethylene:

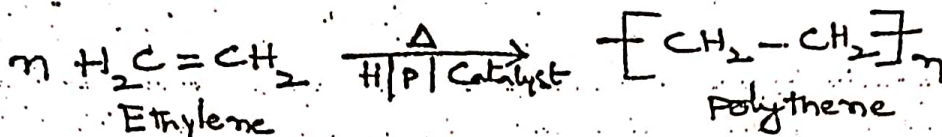

Ex: (ii) Polymerisation of vinyl chloride:

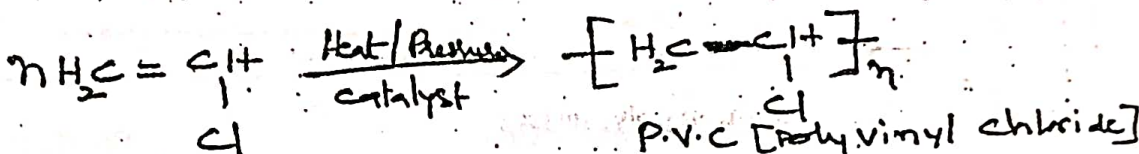

Ex: (iii) Polymerisation of styrene:

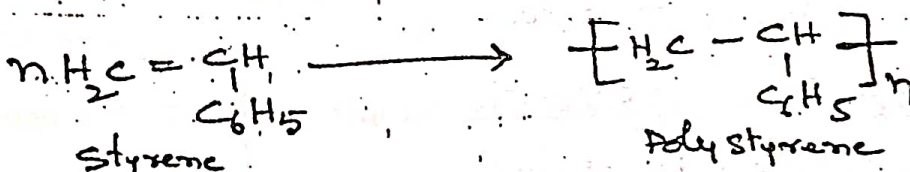

Condensation polymerization (or) Step wise polymerization:

In condensation polymerization, the polymer will form by step-wise reaction between the same (or) different polar group containing monomers with elimination of small molecules like H₂O and HCl and NH₃.

Ex: Nylon6,6, Novolac, Bakelite, polyester.

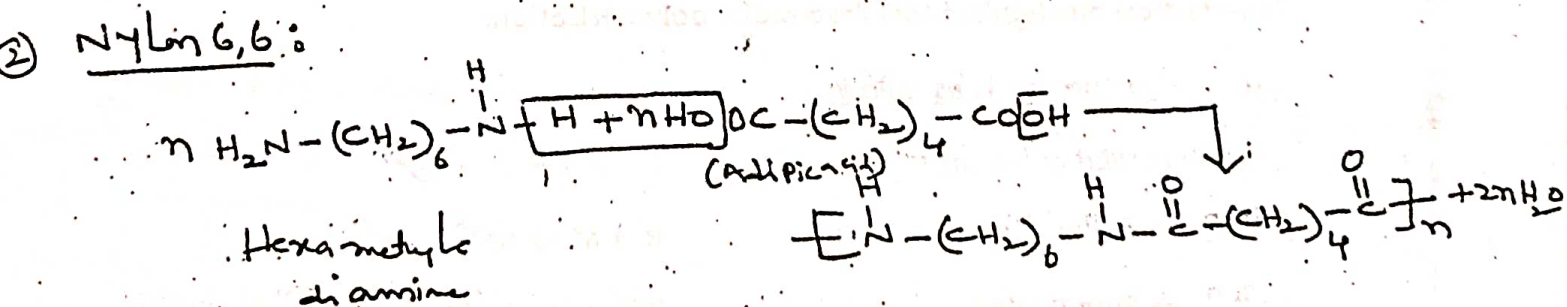
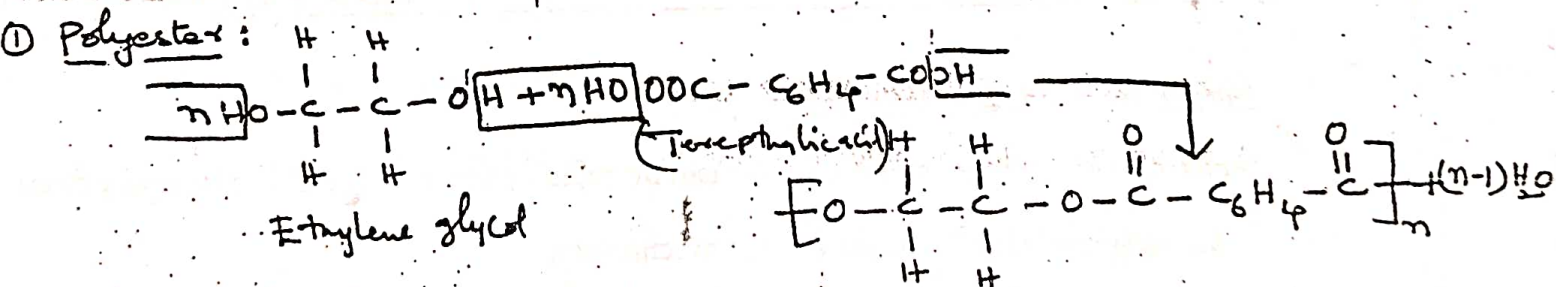

CO-Polymerisation:

When two (or) more different types of monomers undergo simultaneous polymerization. It is called co-polymerisation.

Ex: GR-S rubber (r) Styrene rubber (r) BUNA-S Rubber

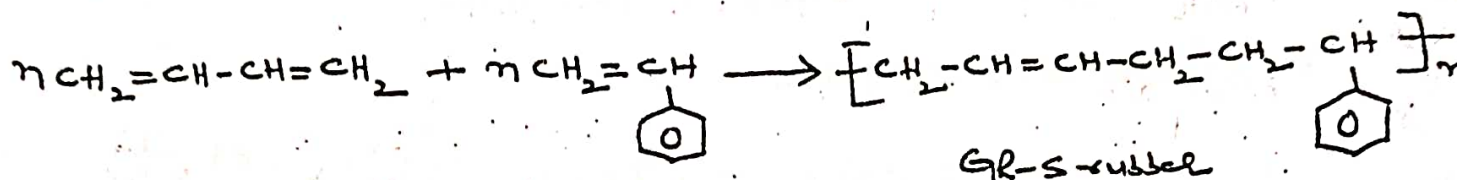

Addition polymerisation	Condensation polymerisation
1. Addition polymerisation takes place between same monomer units	1. Condensation polymerisation takes place between two (or) more monomers.
2. This reaction proceeds in a fast manner	2. Reaction proceeds comparatively slowly
3. No byproduct is formed.	3. Byproducts are formed.
4. High molecular weight polymer is formed	4. Molecular weight of the polymer increases steadily throughout the reaction.
5. Thermoplastics are produced	5. Thermosetting plastics are produced
6. Homo-chain polymer is obtained	6. Hetero-chain polymer is obtained

Mechanism of addition polymerization:

Mechanism of addition polymerization can be explained by any one of the following types

1. Free radical mechanism
2. Ionic mechanism.

Free radical mechanism (or) Free radical polymerization:

The reaction proceeds as follows:

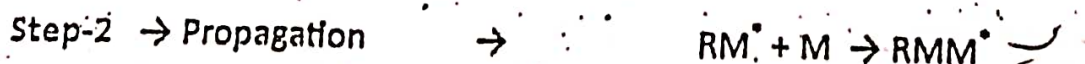
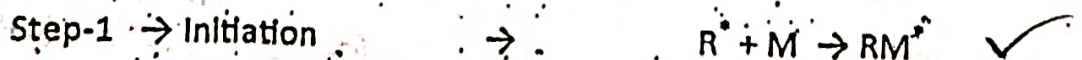



A low molecular weight compounds like azo compounds, peroxide, Hydro peroxides are useful as Initiators.

This can be explained by the polymerization of vinyl chloride.

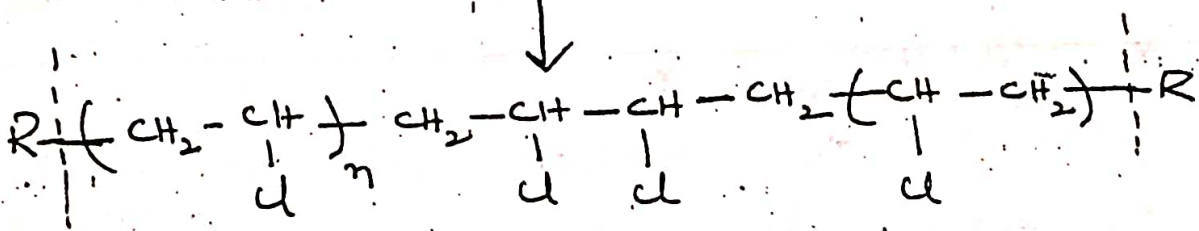
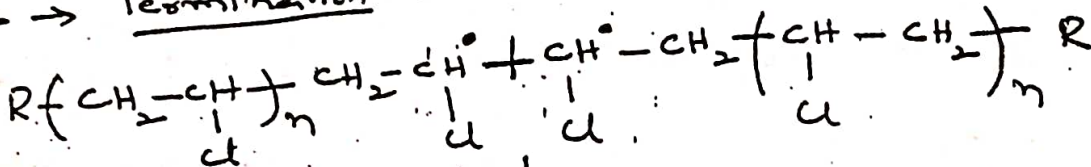
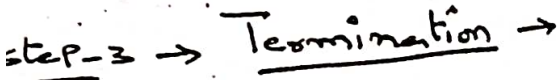
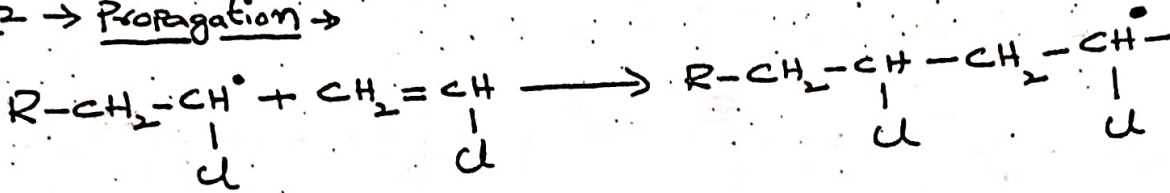
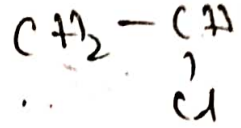
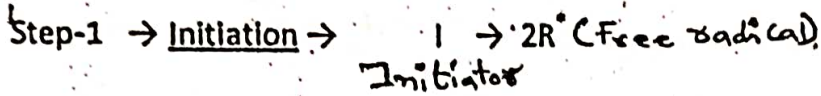

Termination by coupling.

Ionic mechanism (or) Ionic polymerization

Depending on the nature of ions ionic polymerization takes place in two ways.

i) Cationic addition polymerization

Step-1 → Initiation

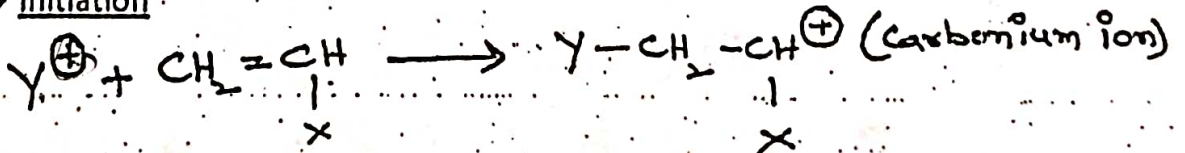

Step-2 → Propagation

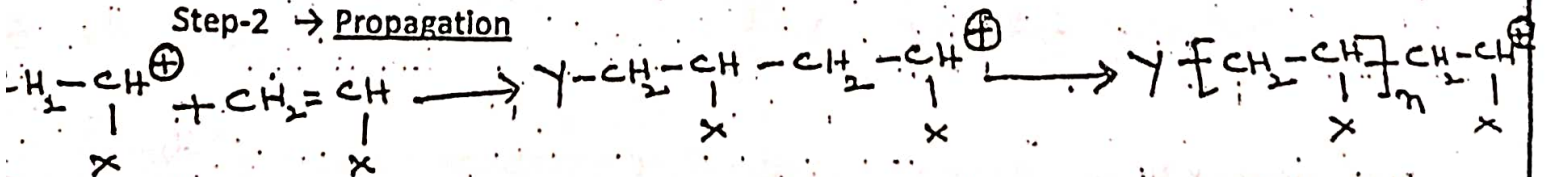

Step-3 → Termination

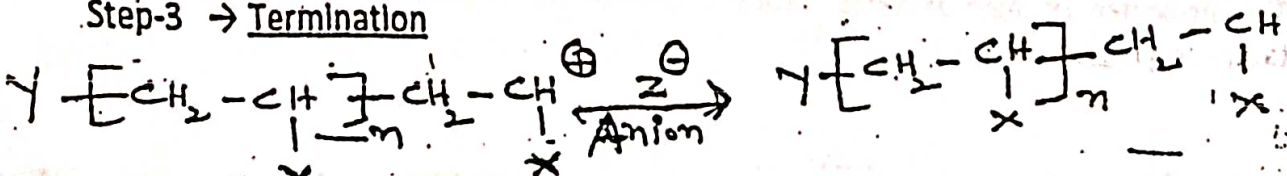

(ii) Anionic addition polymerization

Step-1 → Initiation →



Step-2 → Propagation →

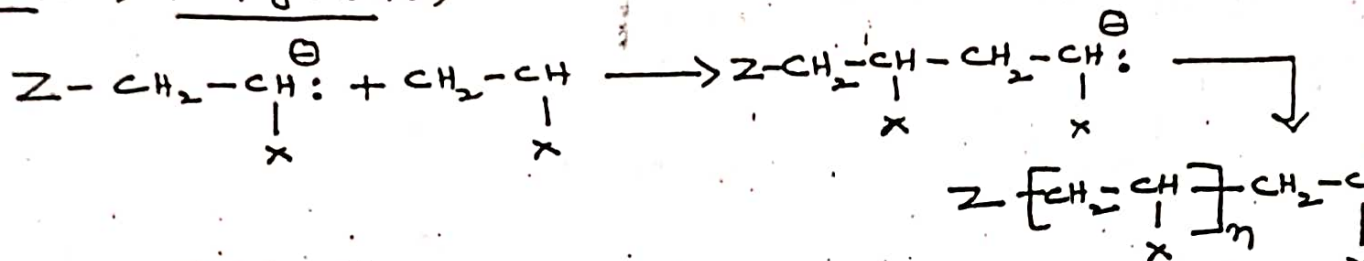

Step-3 → Termination →

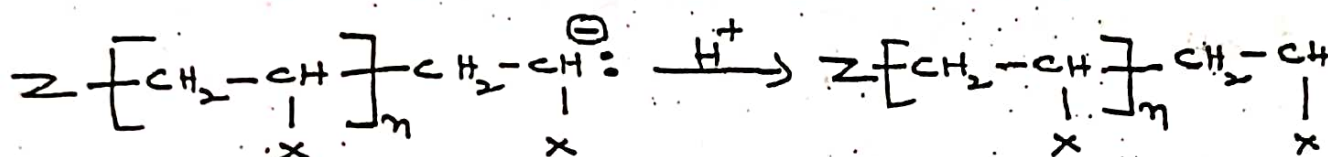

Ziegler-natta polymerization (or) Co-ordination polymerization

The mixture of titanium halides and tri alkyl aluminum is known as Ziegler-natta catalyst.



In this process tri alkyl aluminum adsorbs on the surface of titanium chloride and forms electron deficiency bridge structure.



In this structure, titanium chloride acts as catalyst and alkyl aluminum acts as co-catalyst.

In the presence of Ziegler-natta catalyst co-ordination polymerization occurs and gives isotactic polymer.

Mechanism :-

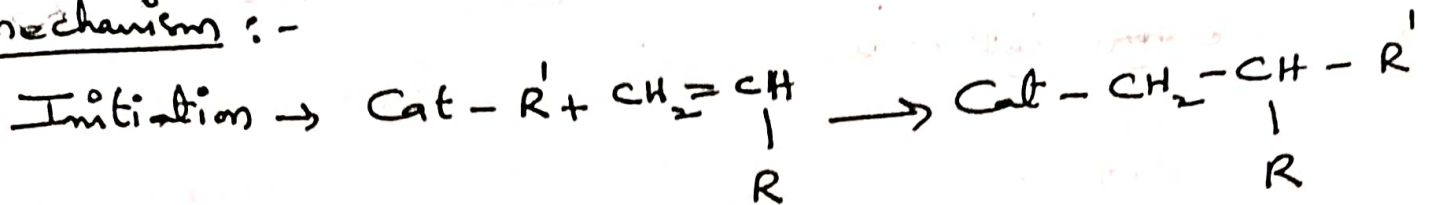

Propagation \rightarrow

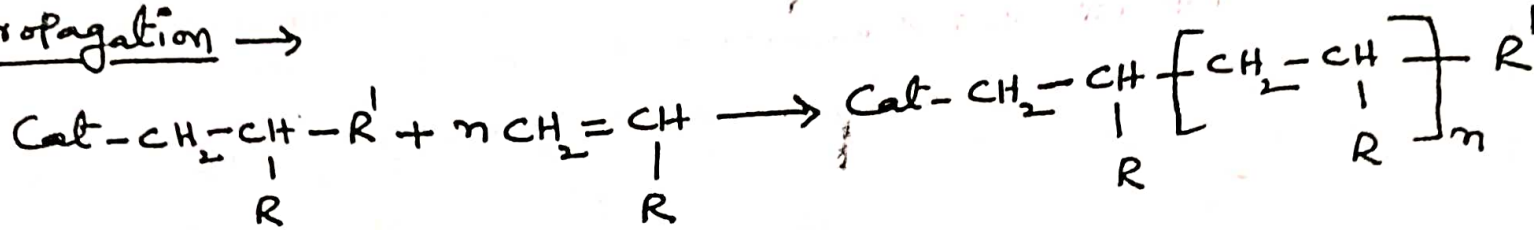

Termination \rightarrow

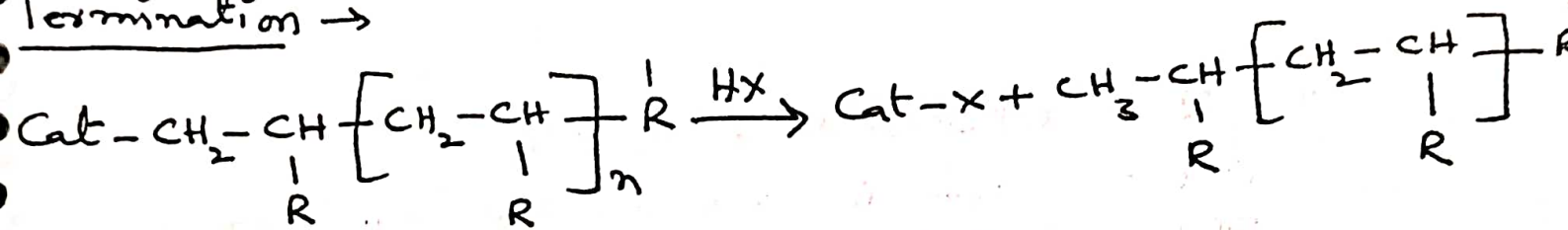

Condensation Polymerisation mechanism

Generally two types of Condensation Polymerisation occurs

(i) AA-BB type polymerisation

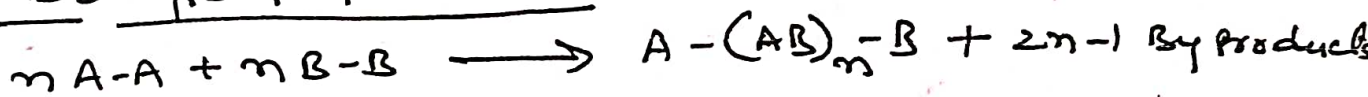

(ii) A-B type polymerisation

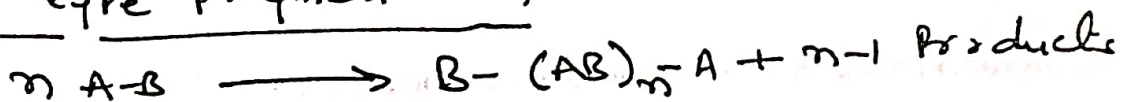

Plastic (or) Resins :-

Plastics are high polymers which can be moulded in to any shape by application of heat and pressure in presence of catalyst

Properties :- (i) Light weight & high strength to weight ratio

(ii) Good thermal and electrical insulation (iii) High Corrosion resistance

(iv) Easy workability ~~etc~~ Casting, molding, drilling etc.

(v) High Chemical inertness (vi) Low maintenance cost.

Classification of Plastics:

Plastics are classified in to two types

(i) Thermoplastics

(ii) Thermosetting plastics

Thermoplastics (or) Thermoplastic resins:

These are the polymers which become soft on heating and hard on cooling. On reheating, they become soft again and can be remolded to desired shape. During the action of heating weak secondary vanderwaal's forces are broken while on cooling, these secondary bonds are re-established. Ex: PVC, Polythene, Teflon, Polystyrene.

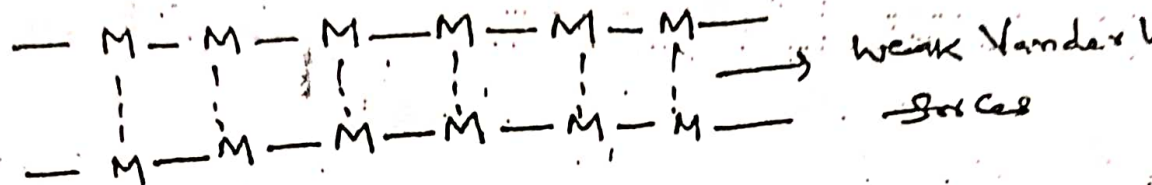

ii) Thermo setting plastics (or) Thermo setting resins

These are the polymers which are fusible on initial heating and later cannot be softened by heating. Once they are set on heating they cannot be reformed. Because of strong covalent bonds. Ex: Bakelite, polyester, Urea formaldehyde resin etc.

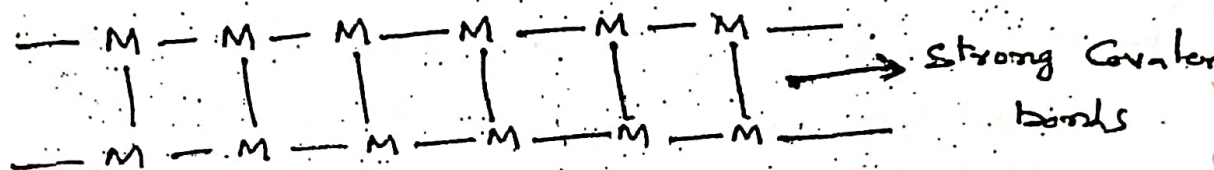

Differences between Thermo & Thermosetting plastics:

Thermoplastics	Thermosetting plastics
1. The resins are produced by addition polymerisation	1. Resins are produced by condensation polymerisation
2. They are made up of long chain	2. These resins have three dimensional network structure connected bonds.
3. They are soften on heating and harden on cooling.	3. They are fusible on initial heating only.
4. High molecular weight polymer is formed	4. Molecular weight of the polymer rises steadily throughout the reaction.
5. Thermoplastics are produced	5. Thermosetting plastics are produced.
6. Homo-chain polymer is obtained	6. Hetero-chain polymer is obtained

Composition, Properties and Applications of

- (i) Nylon 6,6
- (ii) Bakelite
- (iii) Urea-formaldehyde resin
- (iv) Carbon fibres

Nylon 6,6: It is obtained by the polymerization of adipic acid with Hexamethylene diamine.

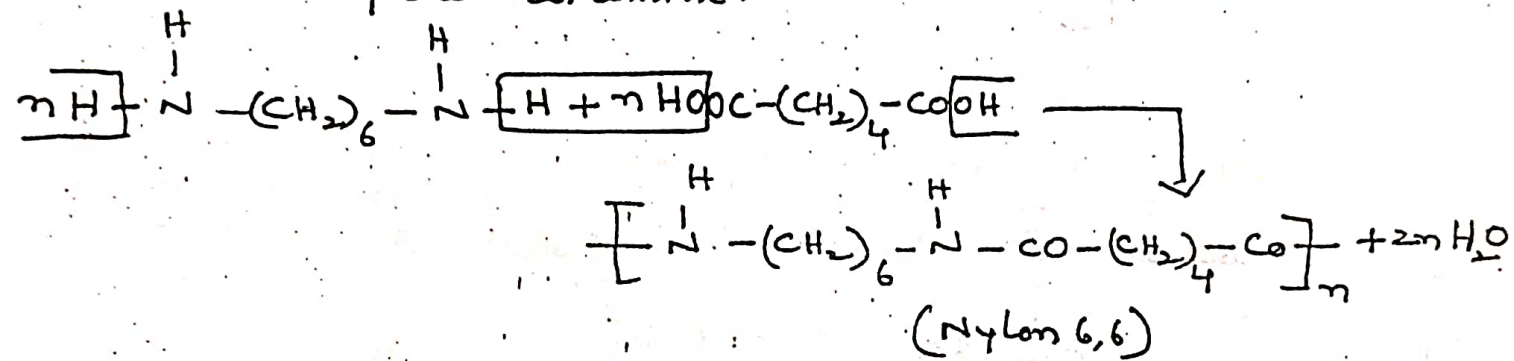

uses :- Nylon 6,6 is used as fibres for making socks, dresses, carpets, undergarments etc.

Bakelite (or) Phenol-Formaldehyde resin (or) Phenol plastics

Preparation :- Bakelite is obtained by the Condensation polymerisation of Phenol and Formaldehyde in the presence of an acid (or) alkali catalyst.

1st step : Phenol reacts with Formaldehyde to form o-hydroxy methyl phenol and p-hydroxy methyl phenol

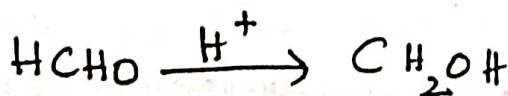

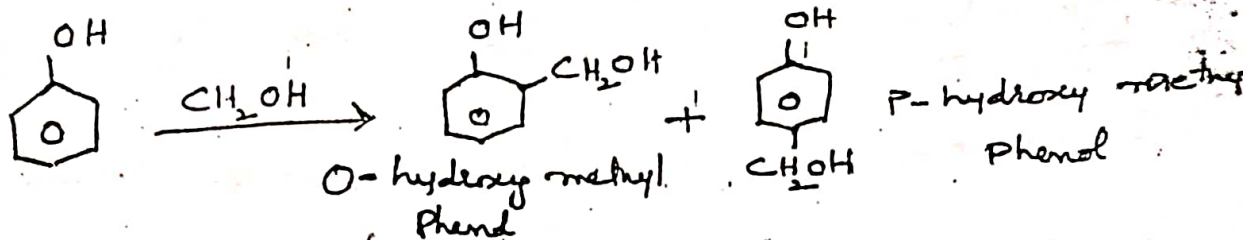

2^d Step: Condensation between hydroxyl methyl phenol and phenol to give linear polymer (Novolac)

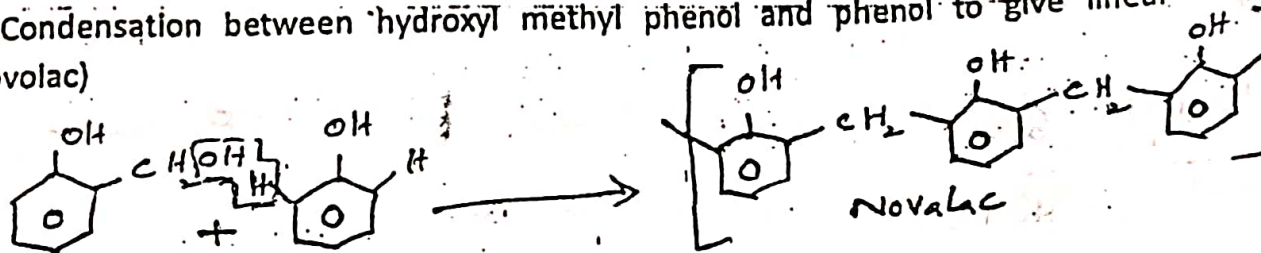

3^d Step: Small amount of hexamethylene tetramine is added. It produces formaldehyde and ammonia formaldehyde converts the soluble and fusible novolac into hard. This infusible solid cross linked three dimensional polymer called bakelite.

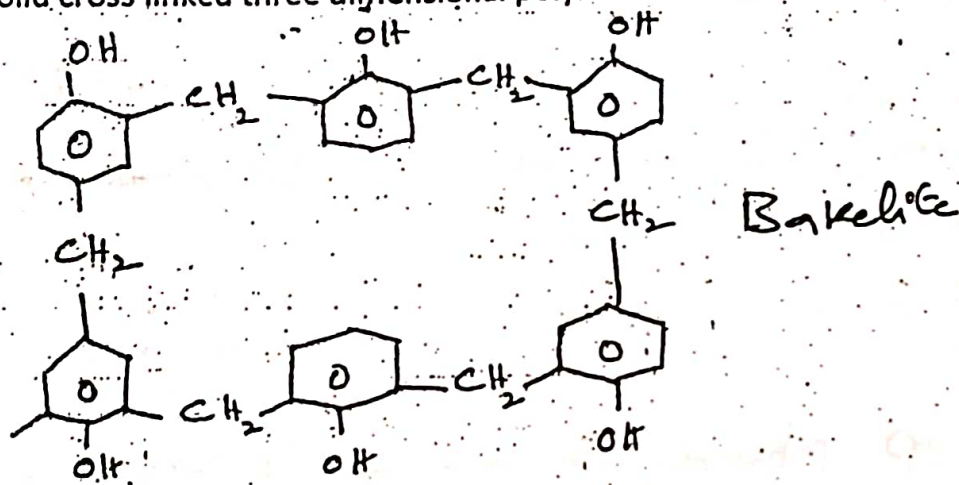

Properties: i) Bakelite is very hard, infusible and rigid.

ii) It has high resistance towards heat, moisture and chemicals.

iii) It has very good electrical insulating properties.

USES: i) Bakelite is used for making electric insulator parts like switches, plugs, switch boards etc.

ii) It is used for making articles like telephone parts, radio, and T.V. Cabinets.

iii) Bakelite used in paints and varnishes iv) It is used for making bearings and in grinding wheels.

NYLON (Polyamides)

The polymers having polyamide linkage are called Nylons. These are obtained by step (or) condensation polymerization.

Teflon ✓

7

It is a polymer of Tetrafluoro ethylene $F_2C=CF_2$

Preparation :- It is obtained by polymerisation of water-emulsion of tetrafluoro ethylene in the presence of Benzyl peroxide as catalyst.

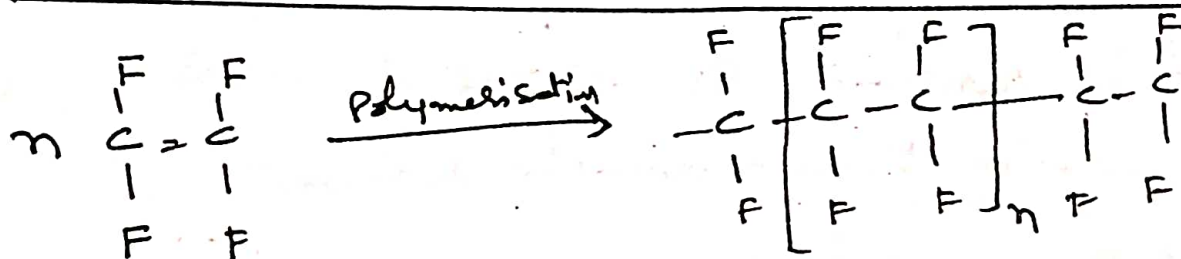
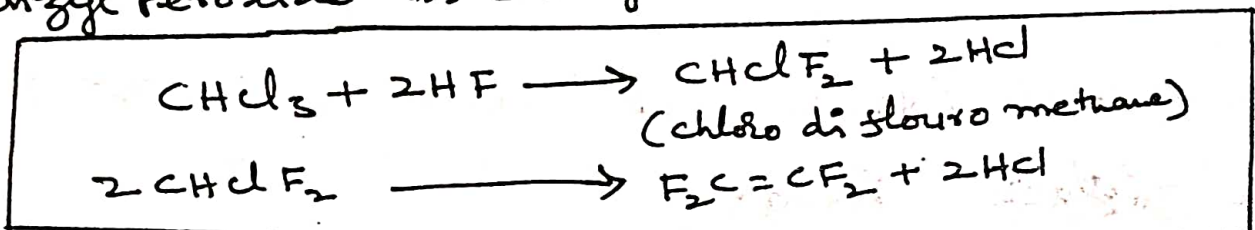

- Properties :-
- (i) High chemical resistance
 - (ii) Not soluble in any solvent
 - (iii) Waxy touch
 - (iv) High melting point
 - (v) Good electrical & mechanical properties
 - (vi) High density (vii) Excellent thermal stability

- Uses :-
- (1) As insulating material for motor, transformer cables, electric wires, fittings
 - (2) For making gaskets, chemical carrying pipes, tubes.
 - (3) For coating on frying pans (non-stick)

PVC (Poly vinyl chloride) ✓

Preparation :-

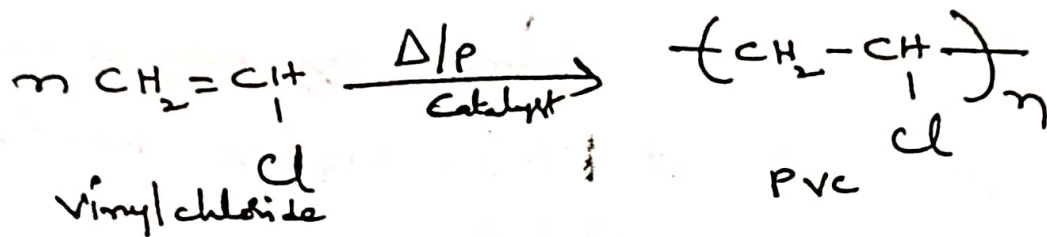

Properties :- (i) PVC is good insulation material & having good dielectric strength

(ii) PVC is resistant to all type of weathering, Chemical rotting, Corrosion, shock & abrasion resistant

(iii) light weight & tough

(iv) PVC is resistant to all inorganic compounds.

Uses :- (a) applications :- PVC is a versatile material that offers

- many possible applications
- (i) making of window frames
 - (ii) ~~to~~ Drainage pipe
 - (iii) water service pipe
 - (iv) used as wire insulation
 - (v) Automotive interiors
 - (vi) Roofing etc.

Carbon fibers:-

8

Carbon fibers (CF) or graphite fibers are fibers composed of no. of carbon atoms and these fibers have diameters of about 5-10 micrometers (μm). These are usually combined with other materials to form a composite.

When carbon fiber is composited with a plastic resin and dried it forms carbon-fiber-reinforced polymer, which has high strength. Carbon-fibers are also composited with other materials such as graphite to form reinforced carbon-carbon composite which have a very high heat resistance.

Preparation:- Carbon fibers are synthesized by the pyrolysis of organic fibers such as cellulose, polyacrylonitrile (PAN) in an inert atmosphere.

Properties:-

1. Carbon fiber has high strength
2. It is corrosion resistance and chemically stable
3. It is non-poisonous, non-flammable.

Uses:-

- 1) They are used as reinforcing material with poly ether resins (or) epoxy resins to form composites, which have high strength than metals.

- 2) These are used in air craft, constructions, biomedical etc.

Conducting polymers:-

Generally polymers are poor electrical conductors, so these are used in electrical insulators.

But some polymers are having conductance property these are known as conducting polymers.

The conduction in the polymers is mainly due to

- (i) ~~presence~~ of conjugation of double bonds in a polymer chain.
- (ii) Addition (or) externally adding of ingredients (or) additive (doping) on a polymer chain.

Ex: (i) Polyacetylene, Poly aniline, Polypyrrole etc.

Preparation of Conducting polymers:-

Conducting polymers are mainly prepared by doping the polymers. In this method introducing charged species and created positive (+ve) charge (or) negative (-ve) charge on a polymer chain.

Types of doping:-

1. P-doping → Using Lewis acid (or) halogens by create positive charge on polymer chain. Ex:- $FeCl_3$, $AlCl_3$, Br_2 , I_2 etc.

2. N-doping → By ~~using~~ using Lewis base (or) alkali metals creating negative charge on polymer chain.

Ex:- NH_3 , PH_3 , Na & K

① Poly acetylene:-

Acetylene Undergo polymerisation gives poly Acetylene.

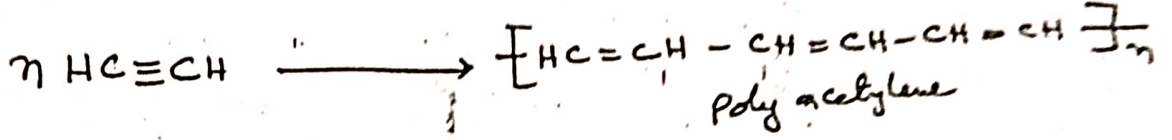

② P-doping:- In this method polyacetylene reacts with Lewis acids like FeCl₃ (Ferric tri chloride) and create (+ve) charge on a polymer chain, so poly Acetylene is converts into conducting polyacetylene polymer.

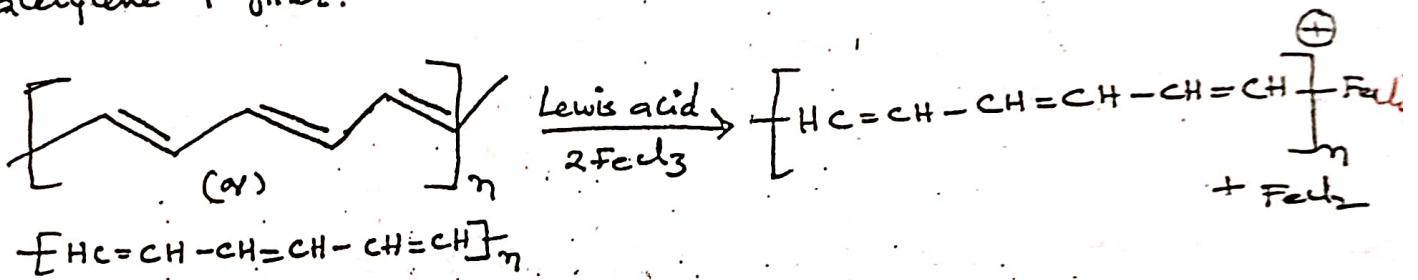

③ n-doping:- In this method polyacetylene reacts with Lewis base like NH₃, PH₃ etc and created (-ve) charge on a polymer chain and which responsible for conduction.

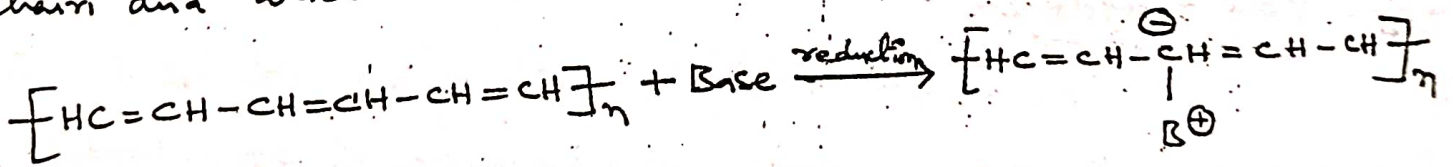

Applications of Poly acetylene:-

- 1) These are used in batteries, microelectronics etc.
- 2) It is used in the development of photovoltaic devices
- 3) It is used in formation of p-n transitions, hetero junctions, etc

1) Poly aniline :-

Aniline undergo polymerisation gives Poly aniline

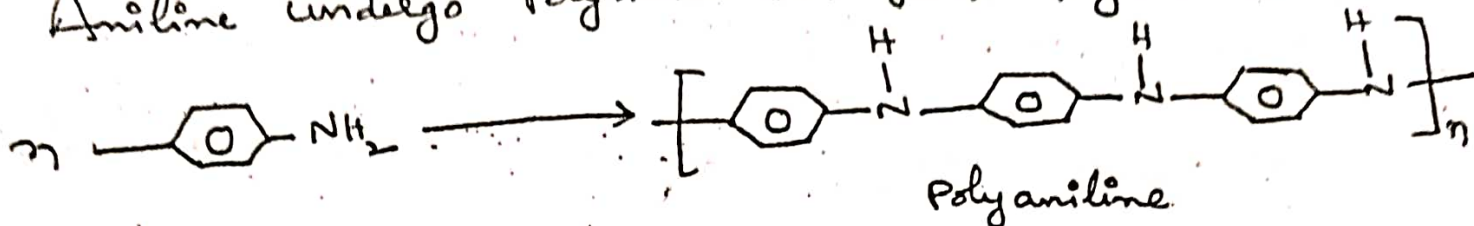

2) P-doping :- In this method poly aniline reacts with acids like HCl and create positive charge on a polymer chain. So, Polyaniline is converted into conducting polyaniline polymer.

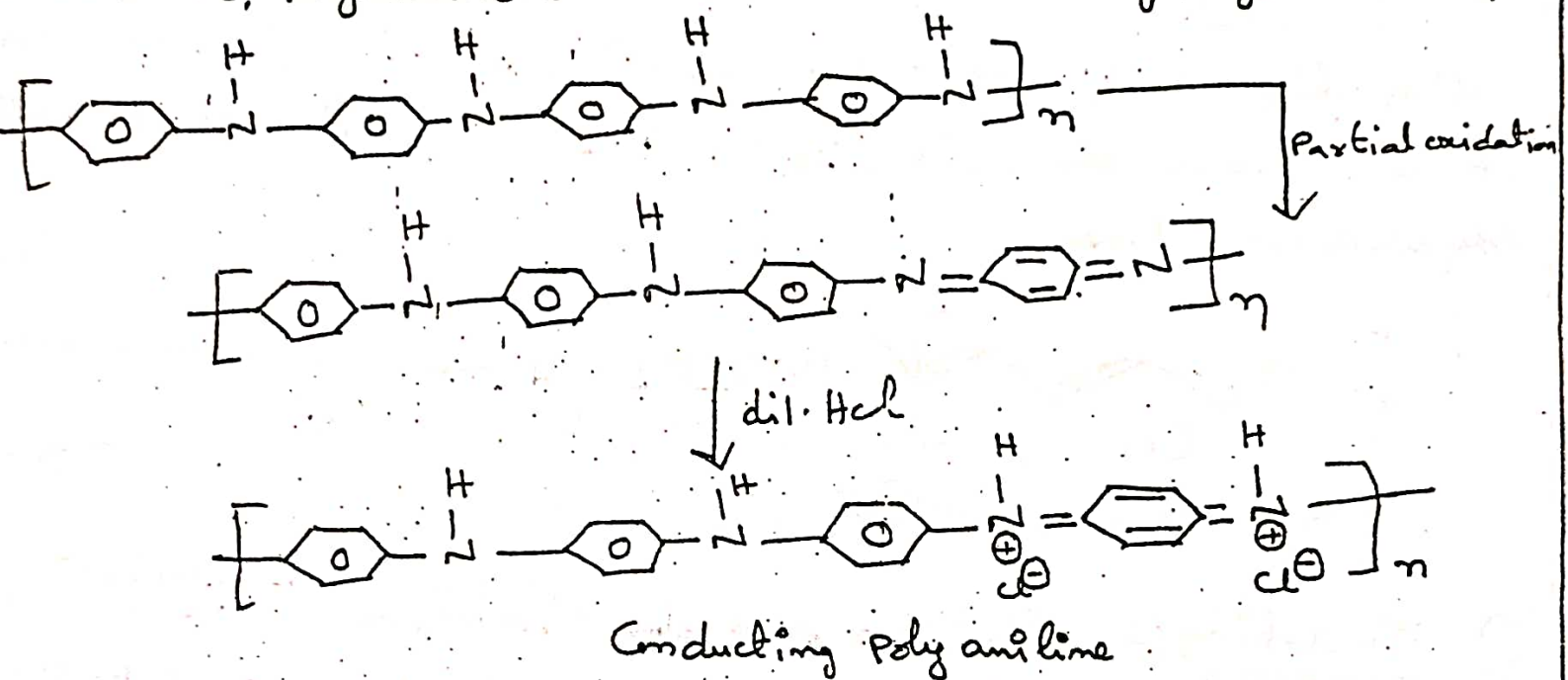

3) Poly pyrrole :-

Pyrrole undergo polymerisation gives Poly pyrrole. It is a very good conducting polymer with conjugation of double bonds.

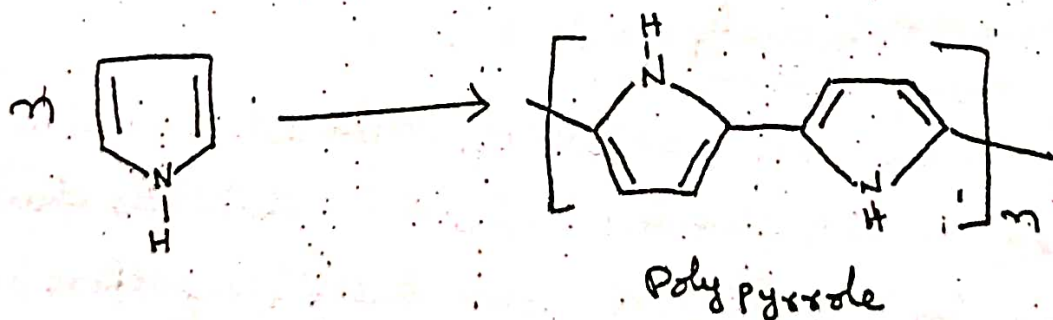

P-doping :-

In this method polypyrrole reacts with Lewis acids like $FeCl_3$ and create (+ve) charge on a polymer chain. So, Polypyrrole is converted into conducting polypyrrole polymer.

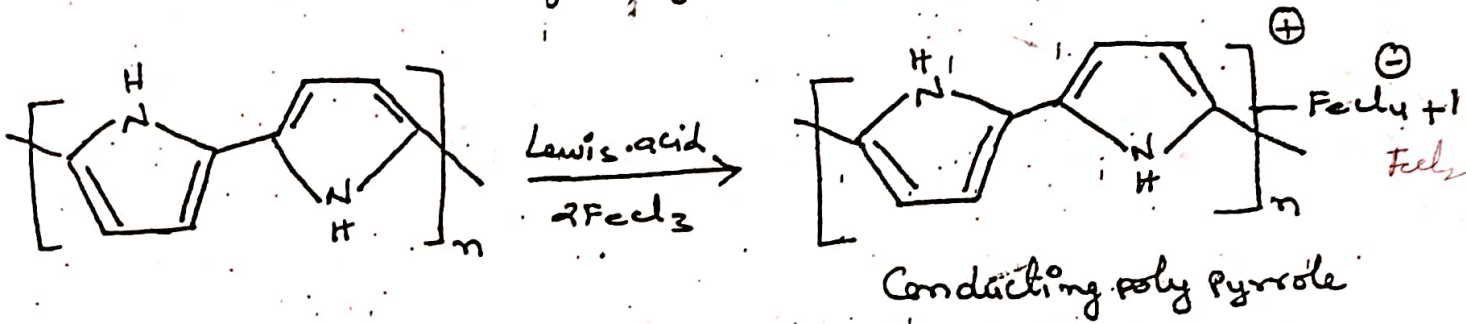

Applications of polypyrrole :-

- ① It is used for the catalyst in fuel cells.
- ② It is used as a corrosion resistant.
- ③ These are used in biosensors, gas sensors, light weight-rechargeable batteries etc.

Applications of polyaniline :-

- ① It is used as a corrosion resistant.
- ② It is used in Printed Circuit Boards (PCB), sensors, etc.
- ③ It is used as a coating for films etc.

Biodegradable Polymers :-

A polymer that can be decomposed by micro-organisms (bacteria) is called a biodegradable polymer.

Ex:- Poly (Glycolic Acid) (PGA),
Poly (Lactic Acid) (PLA), etc

1) Poly (Glycolic Acid) [PGA] :-

Poly Glycolic acid is an example of biodegradable polymer.

Preparation:- PGA is prepared by condensation

polymerization of glycolic acid monomers in the presence of catalyst.

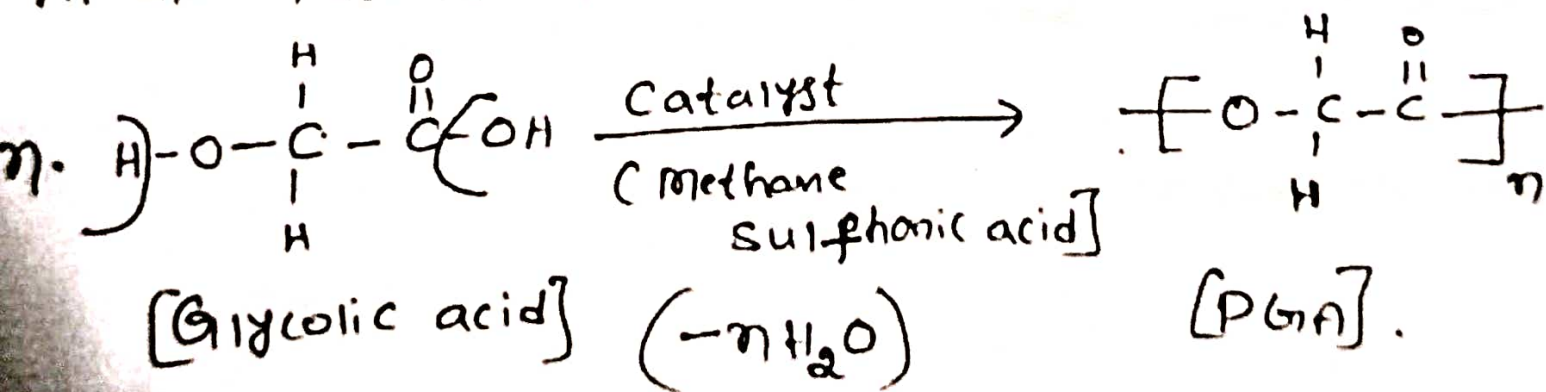

Properties:-

- i) It is chemically inertness.
- ii) It is resistance to corrosion process
- iii) High tensile strength

Applications: - 1) It is used in Agricultural activity.

ii) It is used in waste management,

iii) Pbn used in biomedical applications, etc.

Ex: - orthopedic, dental, etc.

2) Poly (Lactic Acid) (PLA) :-

Poly Lactic Acid (PLA) is an example of biodegradable polymer.

Preparation: - PLA is prepared by condensation

polymerization of lactic acid monomers.

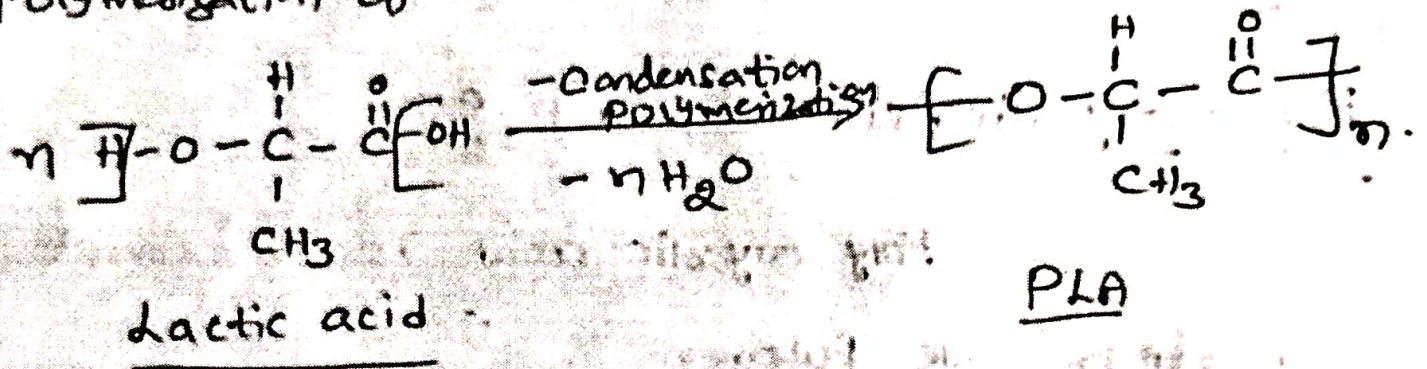

Properties:

1) It is chemical inertness,

2) It has high resistance to corrosion,

oils, etc.

3) It is shiny and transparent.

Applications: - 1) It is used in medical purpose

like stents, etc.

2) It is used in food packaging,

3) It is used in agricultural

activities, etc.

UNIT-V

INSTRUMENTAL METHODS & APPLICATIONS

Spectroscopy

Spectro = Radiation Scopy = Measurement

Def:- Spectroscopy is the study of the interaction between electromagnetic radiation and the substance.

Types of Spectroscopy

It is classified into two types

- 1) Atomic Spectroscopy 2) Molecular Spectroscopy

1) Atomic Spectroscopy:- It deals with the interaction between electromagnetic radiation with atom. During which the atom absorbs radiation and gets excited state from the ground state electronic energy level.

2) Molecular Spectroscopy:- It deals with the interaction between electromagnetic radiation with molecules.

Spectrum:-

① Absorption Spectrum:-

When a beam of electromagnetic radiation is allowed to fall on a molecule in the ground state, the molecule absorbs photon of energy ($h\nu$) and undergoes a transition from the lower energy level to the higher energy level. The spectrum thus obtained is called Absorption spectrum.

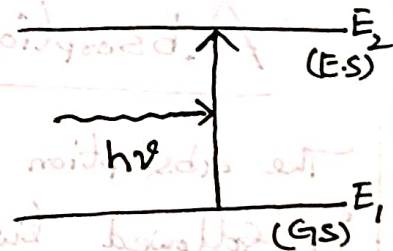

2) Emission Spectrum :-

If the molecule comes down from the excited state to the ground state with the emission of photons of energy ($h\nu$), the spectrum thus obtained is called "emission spectrum".

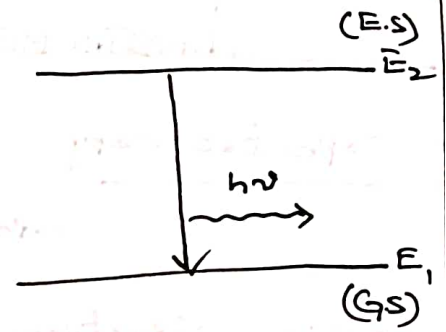

Electro Magnetic Spectrum :-

The arrangement of various types of electromagnetic radiations in terms of increasing (or) decreasing wave length (λ) or frequency is called electro magnetic spectrum.

The wave length of various waves increase in the following order

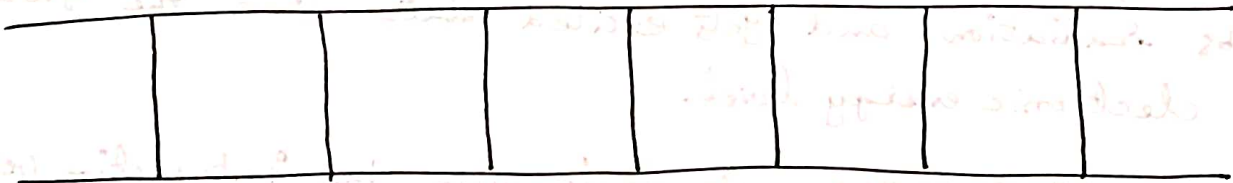

γ-rays X-rays UV-rays visible rays IR-rays M.W-rays Radio waves

γ -rays < X-rays < UV-rays < visible rays < IR rays < microwave < Radio waves

Absorption of radiation

The absorption of radiation (or) absorption of light by any material is followed two laws.

- ① Lambert's law
- ② Beer's law (or) Beer-Lambert's law.

1) Lambert's law :-

According to this law "When a beam of light (α) radiation is passed through a homogeneous absorbing (α) transparent medium, the rate of decrease of intensity with the thickness (t) of absorbing medium is directly proportional to the intensity of light.

Mathematically the Lambert's law may be

$$\text{expressed as } -\frac{dI}{dt} \propto I$$

$$\Rightarrow -\frac{dI}{dt} = KI$$

dI = Small decrease in the

dt = Small decrease in thickness ^{intensity}

$$\boxed{I = I_0 10^{-Kt}}$$

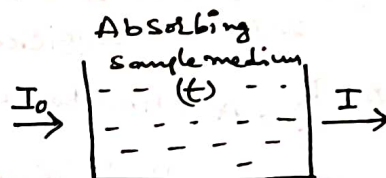

I_0 = Intensity of incident light

I = Intensity of transmitted light

K = Constant

t = Thickness

Beer - Lambert's law :-

According to this law "When a beam of light (α) monochromatic radiation is passed through a solution of absorbing substance, the rate of decrease of intensity of radiation with thickness of the absorbing solution is proportional to the intensity of radiation as well as the concentration of the solution "c"

Mathematical representation as

$$-\frac{dI}{dt} \propto IC \Rightarrow$$

$$\boxed{-\frac{dI}{dt} = KIC} \rightarrow \textcircled{1}$$

On integrating the eq (1) between limits $I = I_0$ at $t = 0$ and $I = I$ at $t = t$, we get

$$\int_{I_0}^I \frac{dI}{I} = - \int_0^t Kc dt$$

$$\ln \frac{I}{I_0} = -Kct \quad (\text{or}) \quad 2.303 \log \frac{I}{I_0} = -Kct$$

$$\Rightarrow \log \frac{I_0}{I} = \frac{K}{2.303} ct$$

Where $\frac{K}{2.303}$ molar absorptivity coefficient

$$\Rightarrow \boxed{A = \epsilon ct} \quad \text{--- (2)}$$

$$\log \frac{I_0}{I} = A = \text{Absorbance}$$

eq (2) is called Beer-Lambert's law.

Thus, the absorbance (A) is directly proportional to molar concentration (c) and thickness (t).

pHmetry :-

Measurement of P^H of a solution using P^H meter is called P^H metry.

P^H metry is a scientific method used to measure the hydrogen ion concentration in water based solution, indicating its acidity (or) alkalinity expressed as P^H . P^H metry is usually carried out by P^H meter.

Principle :-

P^H meter consists of a measuring electrode (glass electrode) and reference electrode (Calomel electrode).

The P^H meter measures the difference in electrical potential between a measuring electrode and a reference electrode.

On integrating the eq (1) between limits $I = I_0$ at $t = 0$ and $I = I$ at $t = t$, we get

$$\int_{I_0}^I \frac{dI}{I} = - \int_0^t Kc dt$$

$$\ln \frac{I}{I_0} = -Kct \quad \text{or} \quad 2.303 \log \frac{I}{I_0} = -Kct$$

$$\Rightarrow \log \frac{I_0}{I} = \frac{K}{2.303} ct$$

Where $\epsilon = \frac{K}{2.303}$ molar absorptivity coefficient

$$\Rightarrow \boxed{A = \epsilon ct} \quad \text{--- (2)}$$

$$\log \frac{I_0}{I} = A = \text{Absorbance}$$

eq (2) is called Beer-Lambert's law.

Thus, the absorbance (A) is directly proportional to molar concentration (c) and thickness (t).

pHmetry :-

Measurement of P^H of a solution using P^H meter is called P^H metry. P^H metry is a scientific method used to measure the hydrogen ion concentration in water based solution, indicating its acidity (or) alkalinity expressed as P^H . P^H metry is usually carried out by P^H meter.

Principle :-

P^H meter consists of a measuring electrode (glass electrode) and reference electrode (Calomel electrode).

The P^H meter measures the difference in electrical potential between a measuring electrode and a reference electrode.

The p^H of the solution is related to the H^+ ion concentration by the following formula.

$$p^H = -\log [H^+]$$

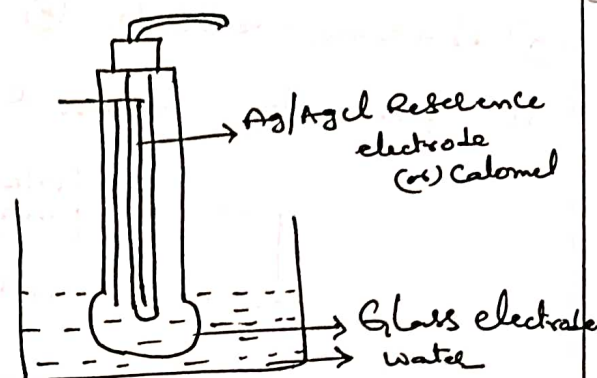

Applications :-

- ① The chemical reactions occur in water, It is useful to measure the nature of water i.e. Acidity (or) Alkalinity
- ② It is useful in healthcare and clinical applications such as blood chemistry
- ③ It is useful to monitor the p^H in agriculture soil water.

Potentiometry :-

Potentiometry is one of the methods of electro analytical chemistry, it is usually employed to find concentration of a solute in solution.

Principle :- It is one of the important method for measuring of emf. The principle involved in the Potentiometry is when the pair of electrodes is placed in the sample solution, it shows the potential difference by the addition of titrant (or) by the change in concentration of ions.

Emf of a cell depends on the concentration of the electrolytes with which the electrodes are in contact. Therefore, the electrode reaction is



As the concentration of M^{n+} changes, the emf of the cell also changes correspondingly.

mainly two electrodes are used in ~~the~~ Potentiometry is
 (A) Reference electrode (B) Indicator electrode, the potential
 is given by Nernst equation

$$E = E_0 + \left(\frac{0.592}{n} \right) \log C$$

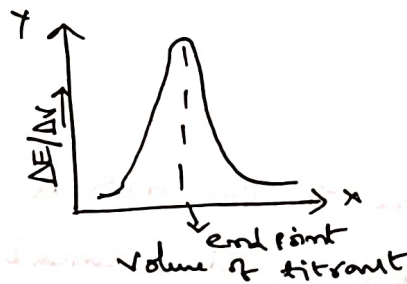
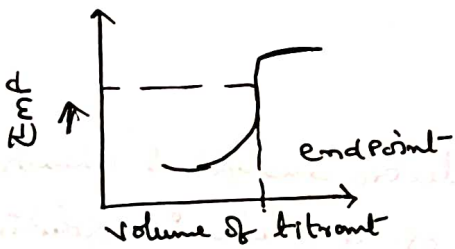
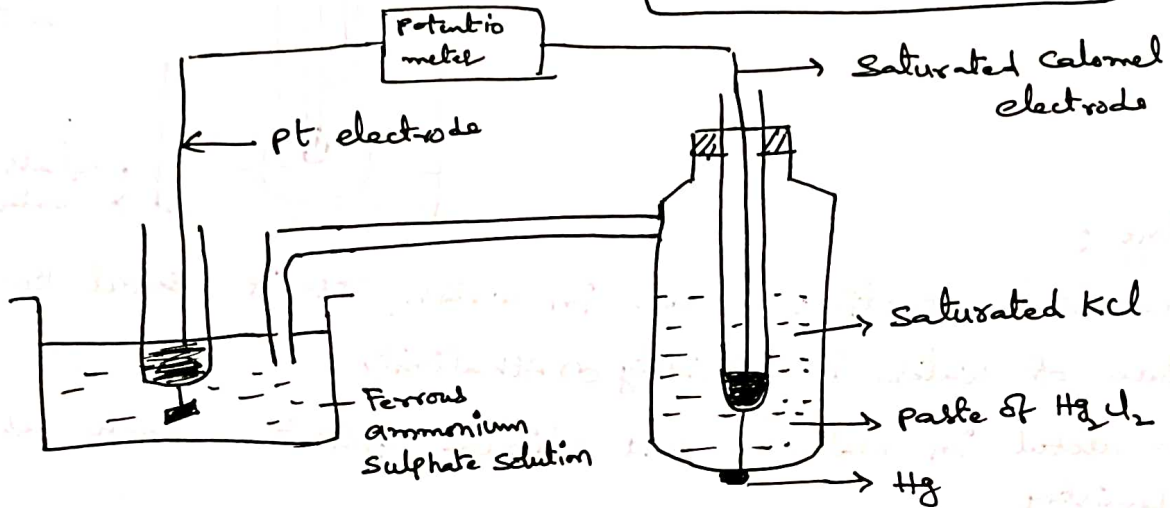

Applications :-

- ① Potentiometry is applicable for measuring the concentrations of solute in low concentrated solutions
- ② These are used for analysis of CN^- , NH_3 in water and waste water
- ③ This type of method is also used in Agriculture like measured the concentration of different salts NH_4 , I , Ca , K , CN etc in soils, plants materials, fertilizers, etc.

UV-Visible Spectroscopy :-

UV-visible spectroscopy is a branch of Absorption Spectroscopy.

Instrumentation → The block diagram of UV-Visible Spectrophotometer is shown in figure.

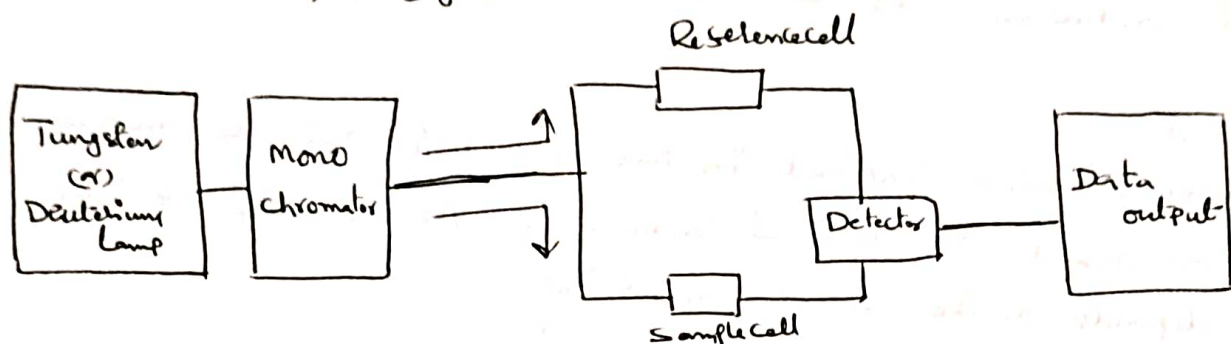

Principle → UV-Visible spectra arises from the transition of valency electrons within a molecule (or) ion from a lower electronic energy level (ground state E_0) to higher electronic energy level (excited state E_1). This transition occurs due to the absorption of UV (wave length 100-400nm) (or) visible (wave length 400-750nm) region of the electronic spectrum by a molecule (or) ion.

The energy absorbed by the molecule (or) sample is equal to the energy difference between excited, ground state of the molecule.

$$\Delta E = E_1 - E_0 = h\nu$$

ν = frequency
 h = Planck constant

Electronic transition depends on the electronic structure of the absorbing medium (Sample)

The two important groups, responsible for absorption and position of absorption in UV-visible spectra are

- ① Chromophores
- ② Auxochromes

① Chromophores :- The presence of one (or) more unsaturated linkages (π -electrons) in a compound is responsible for the colour of the compound, The linkages are referred to as Chromophores

Conductometry

Conductometry is a measurement of electrolytic conductivity to monitor a progress of chemical reaction. It is applied to determine the total conductance of the solution.

Principle :-

The main principle involved in this method is that the movement of the ions creates the electrical conductivity. The movement of ions mainly depends on the concentration of ions.

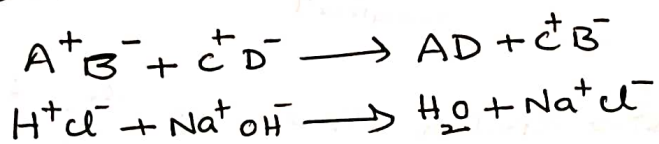

~~where~~ The ionic concentration of A^+ (H^+) is determined by reacting the electrolyte solution with the reagent solution, so that the A^+ ions are replaced by the C^+ (Na^+) ions. This replacement of the ions with the other ions shows the conductance increase (or) decrease.

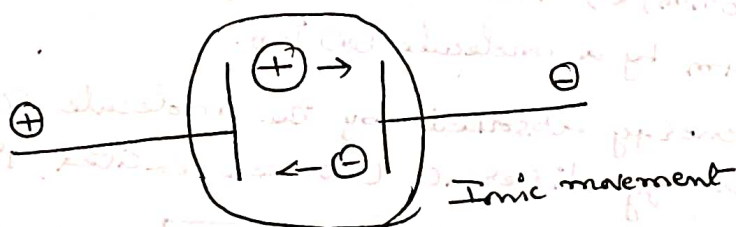

Applications of Conductometry :-

Conductometry is used in the determination of

- (a) Solubility of sparingly soluble salts
- (b) Ionic product of water
- (c) basicity of organic acids
- (d) Salinity of seawater
- (e) Water purity can be monitored

Examples \rightarrow

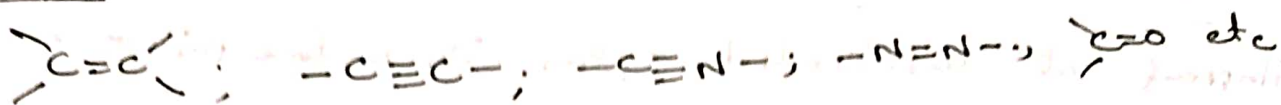

Chromophores undergo $\pi \rightarrow \pi^*$ transition in the short wave length regions of UV-radiations.

2. Auxochrome :- It refers to an atom (or) a group of atoms which does not give rise to absorption band on its own, but when conjugate to chromophore will cause a red shift.

Example: - $-\text{OH}, -\text{NH}_2, -\text{Cl}, -\text{Br}, -\text{I}, \text{etc.}$

Bathochromic shift :- (Red shift) Shift of λ_{max} values

Particularly, short wave length to higher wave length.

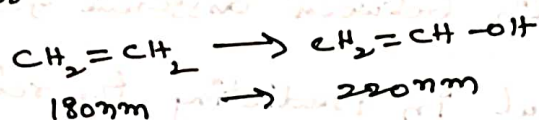

Hypsochromic shift :- (Blue shift) Shift of λ_{max} values Parti-

-cularly higher wave length to lower wave length.

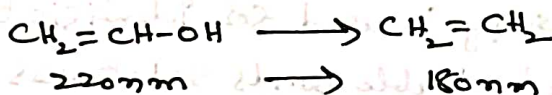

Hyperchromic effect :- An increase in intensity of the peak of the compound.

Hypochromic effect :- A decrease in intensity of the peak of the compound.

Types of transitions involved in organic molecule :-

various electronic transitions are



i) $\sigma \rightarrow \sigma^*$ transition :- This type of transition are possible in saturated system with no lone pairs electrons. It occurs in each and every molecule because every molecule contain σ bond Ex $\rightarrow \text{CH}_4, \text{C}_2\text{H}_6$ etc

(ii) $\pi \rightarrow \pi^*$ transition:-

Happens at unsaturated system with no lone pair of electrons.

Ex: Alkenes, Dienes etc.

(iii) $n \rightarrow \pi^*$ transition:- Saturated molecule having hetero atom

with lone pair electrons Ex \rightarrow Alcohols (C_2H_5-OH), Alkyl halides etc.

(iv) $n \rightarrow \pi^*$ transition:- ~~Saturated~~ Unsaturated molecule having hetero atoms with lone pair electrons. Ex \rightarrow Conjugated Carbonyl, Conjugated Nitro Compounds.

Applications :-

(i) Predicting relationship between different groups:-

UV Spectroscopy is useful in predicting the relationship between

different groups. Ex \rightarrow (i) Between C=C, & C=O double bonds

(ii) Between C=C and aromatic benzene ring double bonds

(ii) UV absorption spectroscopy is used for identification of aromatic compounds and conjugated double bonds substances.

(iii) UV absorption spectroscopy is used for the quantitative determination of compound.

(iv) It is one of the best method for detecting impurities in organic compounds.

(v) Knowing the structure of several vitamins like 'A' and 'K'.

(vi) Determination of Calcium in blood serum.

(vii) Studying kinetics of chemical reactions

(viii) Determination of strength of hydrogen bonding

(ix) Determination of molecular weight of given compound.

(x) Determination of metal ions such as Fe, Mn, etc in cement products - traces etc

Infrared Spectroscopy :- [IR]

IR Spectroscopy is a branch of Absorption Spectroscopy.

Instrumentation :- The block diagram of IR-Spectrometer

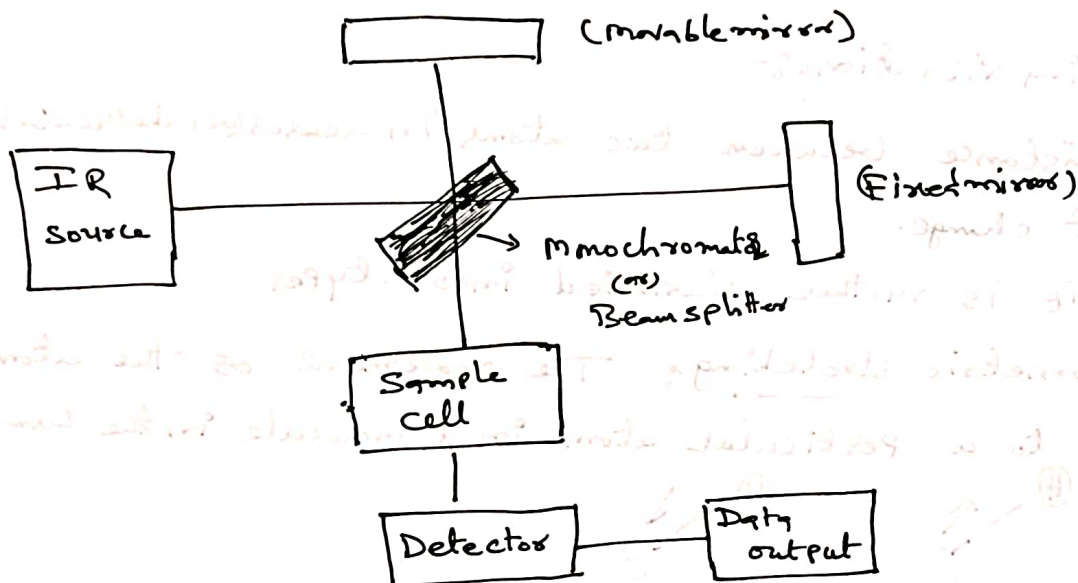

Principle :- In this type of spectroscopy absorption of energy by a molecule in the infrared region and the transitions occur between vibrational levels. So, IR-Spectroscopy is also known as vibrational spectroscopy.

The absorption of IR-radiations causes an excitation of molecule from a lower to the higher vibrational level. IR-spectroscopy is based on the fact that all molecules vibrate and can absorb energy in IR region.

Range of Infrared Radiation

IR is mainly divided into three sections based on wave number (frequency) cm^{-1}

(i) Near infrared (ii) Infrared (iii) Far Infrared

(i) Near infrared :- This region is from $12500 - 4000 \text{ cm}^{-1}$

(ii) Infrared :- This region is from $4000 - 600 \text{ cm}^{-1}$

(iii) Far Infrared :- This region is from $600 - 50 \text{ cm}^{-1}$

Types of vibrations (or) molecular vibrations :-

There are two types of vibrations are present in a molecule.

- (i) Stretching vibrations (ii) Bending (or) deformation vibration.

1. Stretching vibrations :-

The distance between two atoms increases (or) decreases, but bond angle not change.

It is further classified into 2 types

- (i) Symmetric stretching :- The movement of the atoms with respect to a particular atom in a molecule in the same direction

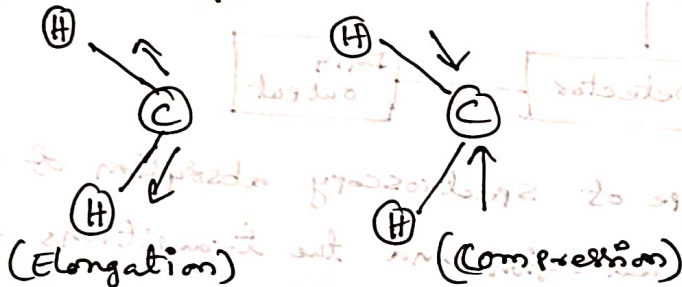

- (ii) Asymmetric stretching :- one atom approaches the central atom but remaining all away from it.

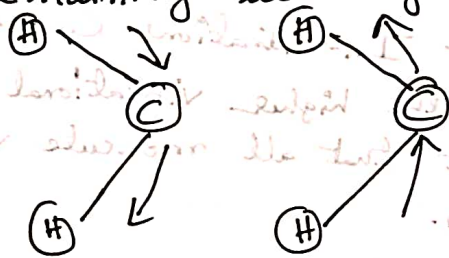

2. Bending vibrations :-

During bending the bond angle increases and decreases but bond distance not change. It is further classified into 2-types.

- (i) In plane bending (ii) out plane bending

① Inplane bending :- It is classified into 2 types.

① Scissoring :- Two atoms approach each other

② Rocking :- Two atoms movement is same direction

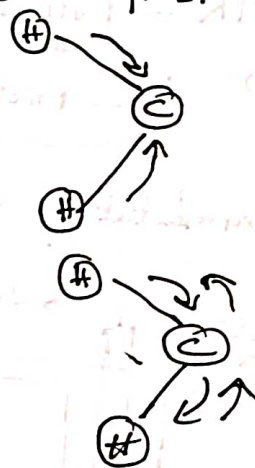

② out plane bending :- It is also classified into two types

① Wagging :- Two atoms same move up (or) move down the plane with respect to the central atom

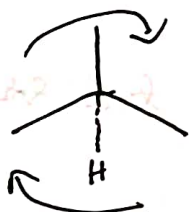

② Twisting :- one atom move up other atom move down

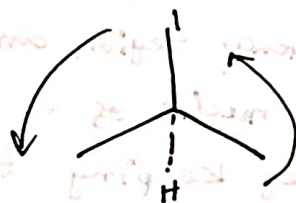

Applications :- (1) Detection of functional groups in organic molecules

- ② To distinguish between intra and inter molecular hydrogen bonding
- ③ Detection of impurities in a sample (or) in raw materials
- ④ Analysis of petroleum, oils and grease, etc
- ⑤ It is used to find the food contaminants in food items
- ⑥ It is used in pharmaceutical drugs in pharmaceutical drugs
- ⑦ Determine the atmospheric pollutants from the atmosphere
- ⑧ To find bacterial & fungal
- ⑨ Identification of an unknown compound
- ⑩ Determination of molecular weight

NMR - Nuclear Magnetic Resonance Spectroscopy

(a) H^1 - Proton NMR Spectroscopy

Instrumentation \rightarrow The block diagram of NMR spectroscopy.

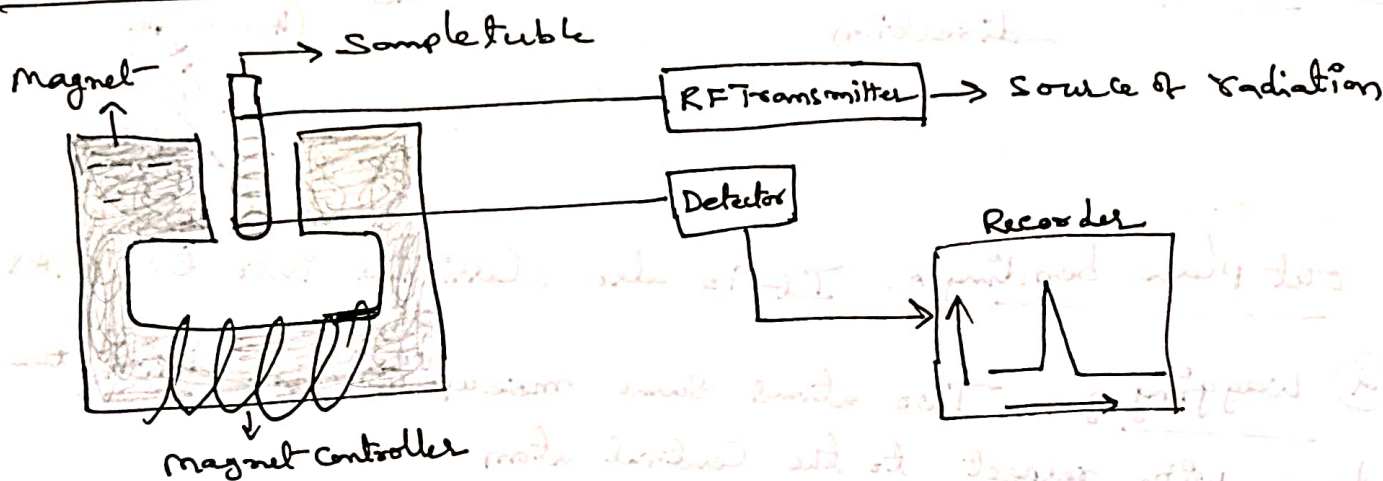

Principle :- NMR is a powerful tool for investigating nuclear structure of atoms and molecules.

In this type of spectroscopy absorption of energy by a atom (or) molecule in the radio frequency region and transitions occur between magnetic energy levels of nuclei of a molecule. The magnetic energy levels are created by keeping the nuclei in a magnetic field.

If the proton is placed in a strong magnetic field the two energy levels become separate. But in the absence of external magnetic field the energy levels are equal.

The energy levels are 1. Low energy level 2. High energy level.

1. Low energy level :- It corresponds to $M_1 = +\frac{1}{2}$ is due to parallel to the direction of magnetic field.

2. High energy level :- It corresponds to $M_1 = -\frac{1}{2}$ is due to anti parallel to the direction of magnetic field.

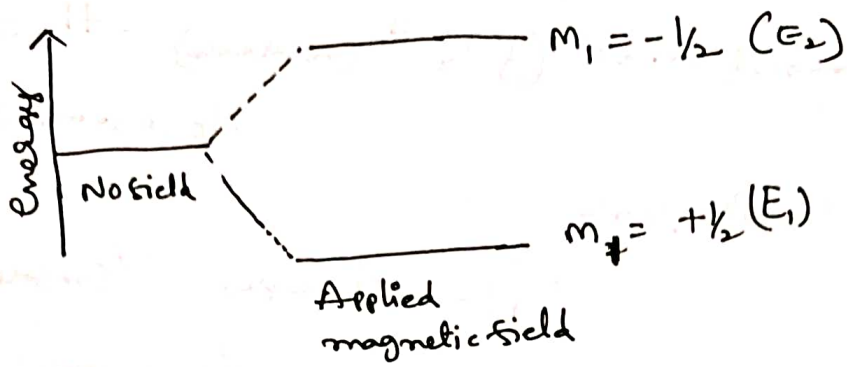

A transition from the lower energy state to the higher energy state can be obtained by providing an equal energy to the difference in energy between the two states.

$$\therefore \Delta E = E_2 - E_1$$

NMR Spectrum :-

On x-axis frequency (ν) y-axis is absorbance, Thus NMR spectrum is plotted between absorption signal at the detector and the strength of the magnetic field (frequency (ν)).

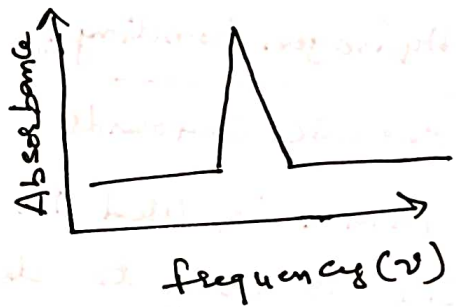

Resonance :- When a nucleus is placed in a system, it absorbs energy and goes to the excited state. Then it loses energy and returns to unexcited state. Again it absorbs energy and goes to excited state. Thus the nucleus which alternatively become excited and unexcited is said to be in a state of "resonance".

Chemical Shift :- (δ)

The position of signal of sample with reference compound is called chemical shift.

The units of chemical shift is ppm(δ) (Tough) and reference (or) standard compound is Tetramethyl silane

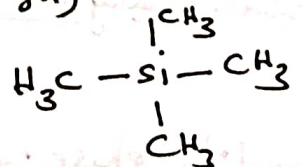

(16)

$$\therefore \text{Chemical shift } (\delta) = \frac{H_0(\text{reference}) - H_0 \text{ Sample}}{H_0(\text{reference})} \times 10^6 \text{ ppm}$$

\therefore In terms of frequency

$$(\delta) = \frac{\nu(\text{sample}) - \nu(\text{reference})}{\nu(\text{reference})} \times 10^6$$

Applications of NMR Spectroscopy :-

- ① Structural diagnosis by NMR :- The structure of an unknown compound can be identified by using NMR-Spectrum.
- ② Hydrogen bonding :- It is used to study the hydrogen bonding in organic compounds.
- ③ NMR is used in advanced medical ~~technology~~ techniques.
- ④ It is used to determination of total concentration of given sample.
- ⑤ It is used to determination of Quantitative analysis of the components in a mixture.

Chromatography

Chromatography is a method for the separation, qualitative identification and quantitative determination of chemical components of complex mixture.

All Chromatography separation techniques used two types of phases like a stationary phase and a mobile phase (solvent, eluent).

Stationary phase :- The stationary phase is a phase is fixed phase. It is fixed in a column.

mobile phase :- The mobile phase is a phase that is moving (or) passing through the stationary phase carrying with the sample mixture.

Gas chromatography :- [GC]

Gas chromatography is a technique used to separate a mixture into its constituents by a moving gas phase passing over a stationary phase or adsorbent.

Instrumentation :-

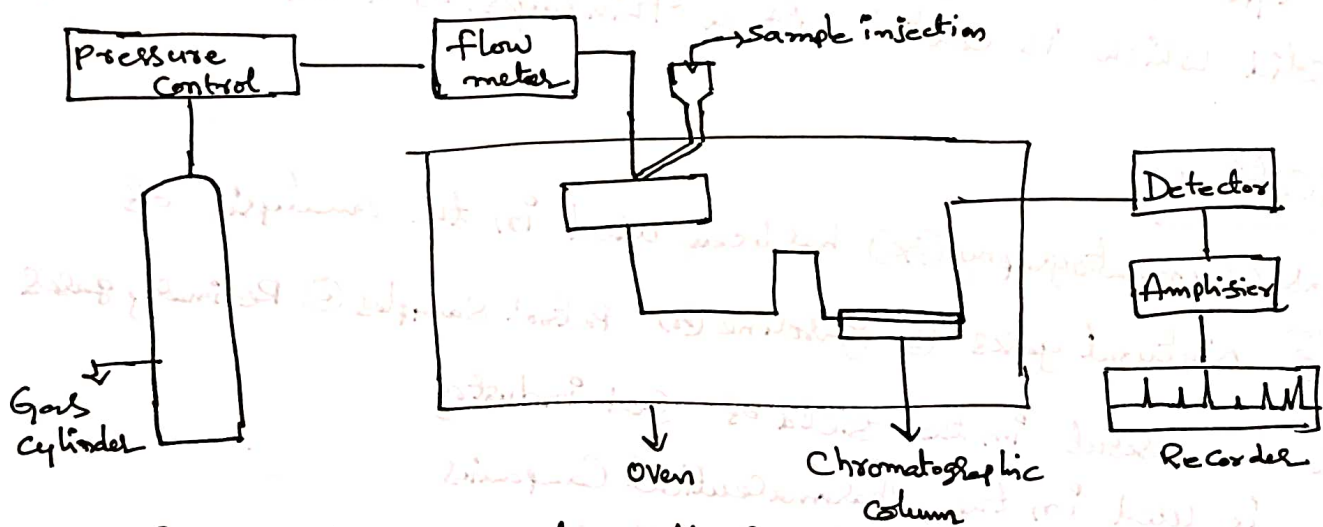

The GC is made up of the following main components (i) Cylinder containing a carrier gas - He, N₂, Ar, etc. (ii) A sample injection system (iii) Column (iv) oven (v) Detector (vi) Recorder.

Principle :- In GC a small amount of sample mixture is vaporised in the carrier gas (mobile phase) and passed at a constant flow rate through a column containing the stationary phase maintained at a particular temperature.

The components of a sample mixture get separated due to differences in boiling point, solubility in the stationary phase.

Types of gas chromatography :-

Based on the nature of stationary phase GC can be divided into 2-types

- ① Gas-Solid Chromatography (GSC)
- ② Gas-Liquid chromatography (GLC)

① Gas-Solid Chromatography (GSC) :-

(Adsorption of gases on the surface of solid)

This type of technique stationary phase of column packed with solid compounds like silica, alumina and involving process of adsorption.

② Gas-Liquid Chromatography (GLC) :-

This type of technique stationary phase of column packed with a porous solid which is coated with a thin layer of a non-volatile liquid.

Applications :-

① Gas chromatography (GC) has been used in the analysis of

(a) Natural gases (b) gasoline (c) Petrol samples (d) Residual gases

② It is useful in the field of food industry

③ It is used in the pharmaceutical companies

④ It is useful in the polymer industries

⑤ Separation of mixture of components having close boiling points

can be done by GC.

High Performance Liquid Chromatography :- [HPLC]

Liquid chromatography is a technique used to separate a mixture into its constituents by a moving liquid phase passing over a stationary adsorbent (or) stationary phase. High pressure pumps operating at high pressure, the solvent (liquid phase) is passed through the column effectively and high speed. So this technique is known as high speed liquid chromatography and High Performance liquid chromatography (HPLC)

Instrumentation :-

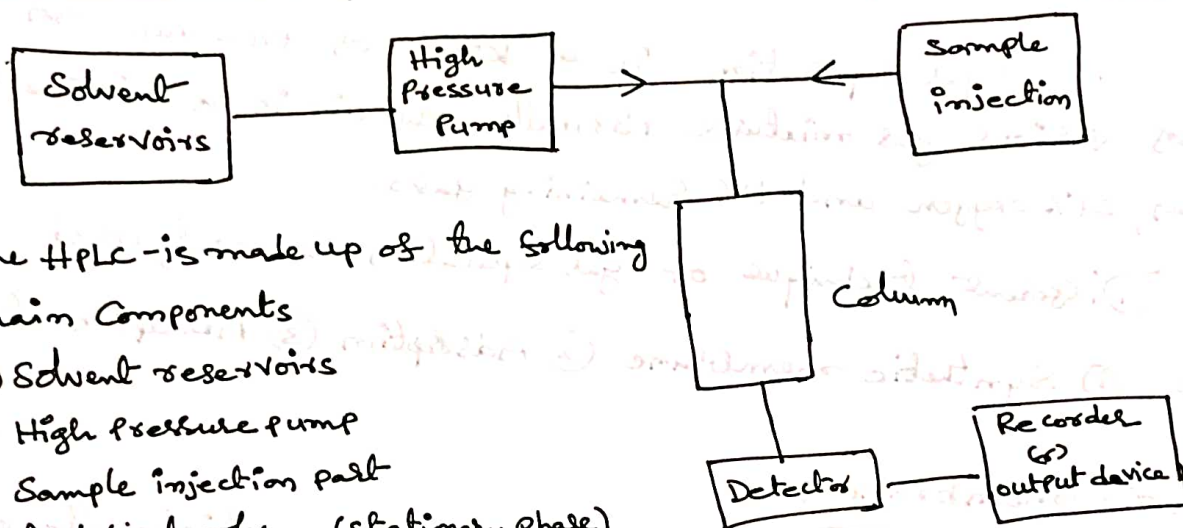

The HPLC is made up of the following main components

- (i) Solvent reservoir
- (ii) High pressure pump
- (iii) Sample injection part
- (iv) Analytical column (stationary phase)
- (v) Detector (vi) Recorder (or) output device

Principle :-

HPLC is an advanced method of column chromatography. Even micro-gram to gram quantities of mixtures can be separated by passage of sample by high pressure flow of a liquid mobile phase through a column containing a stationary solid phase.

The components of a sample mixture get separated due to differences in charge, size, affinities in the stationary phase.

Applications :-

- (1) HPLC is mainly used in pharmaceutical companies
- (2) It is used for checking the quality of products in food industry

Pesticides, industries etc

- ③ It is used for separation of vitamins, lipids at low quantities
- ④ It is used for separation of similar molecules.
- ⑤ Separation of carbohydrates in a mixture of carbohydrates etc.

Separation of Gaseous mixtures :-

Atmospheric air is the raw material for producing most of the gases and the separation process of any gas mixture into its individual components is called as "gas separation"

Gas separation is a kind of procedure for the separation of various gas mixtures. Normally the air is a mixture of 78% Nitrogen, 21% oxygen and 1% remaining gases.

Different technique of gas separation commonly used

That are ① Synthetic membrane ② Adsorption ③ Absorption etc.

① Synthetic membranes :-

These membranes are the porous in nature which allow only certain specific gas molecules to pass through the synthetic membrane. The synthetic membrane allows the gas-A from the mixture of gas (A+B) because this membrane is specific to allow only gas A from mixture of gases (A+B). When applying suitable pressure through the piston the gas molecule A is separated.

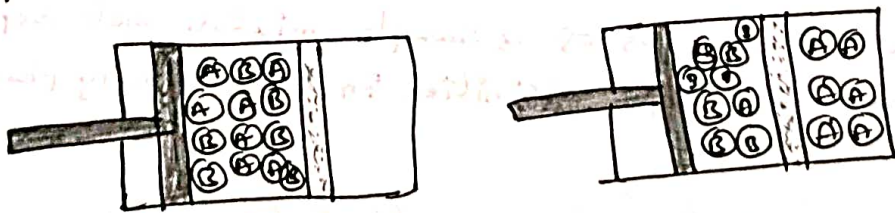

Ex: A thin metal sheet ~~representation~~ is shown of Pd (Palladium) allows only H_2 gas in a mixture of H_2 and O_2 (or) H_2 and N_2 etc.

Separation of liquid mixtures :-

Different techniques of liquid separation commonly used

That are (1) Fractional distillation (2) Centrifugation
(3) Separating funnel (4) Chromatography etc

Fractional distillation :-

Fractional distillation is used for the separation of a mixture of two or more liquids which have the difference in boiling points.

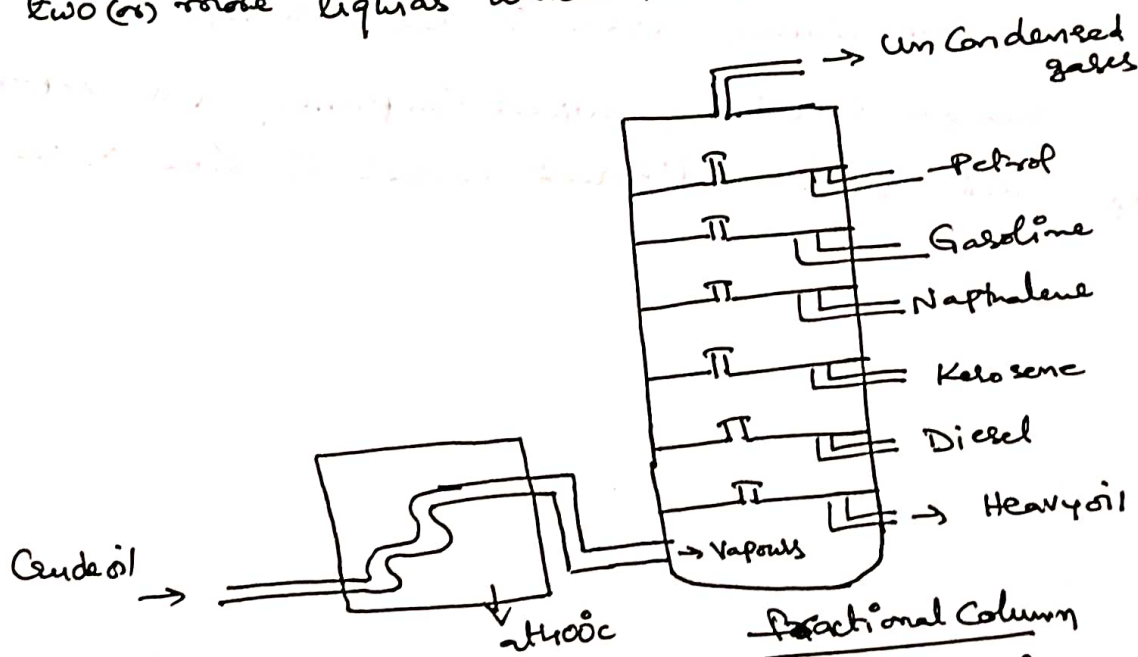

The process of separation of variable products from the crude oil based on the difference in boiling temperature are known as "fractional distillation".

The crude oil is passed to furnace and converts into vapour state, this is due to in furnace maintained temperature is 400°C .

The vapour from crude oil passed to tall fractional column from furnace.

The tall fractional column consists of no. of steel trays each tray providing loose cap with a small chimney. As the vapours go up from down of the fractional column they begin to cool, i.e. decrease of temperature and condensation takes place at different levels of the column.

Separation of liquid mixtures :-

Different techniques of liquid separation commonly used

That are (1) Fractional distillation (2) Centrifugation
(3) separating funnel (4) Chromatography etc

Fractional distillation :-

Fractional distillation is used for the separation of a mixture of two or more liquids which have the difference in boiling points.

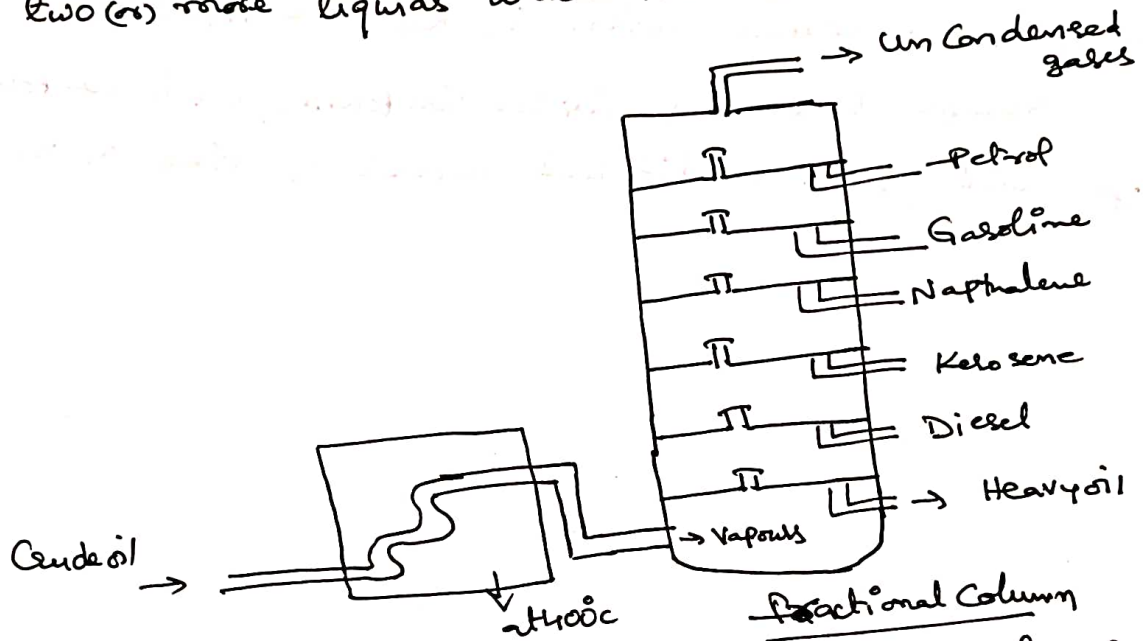

The process of separation of variable products from the Crude oil based on the difference in boiling temperature are known as "fractional distillation".

The Crude oil is passed to furnace and converts into vapour state, this is due to in furnace maintained temperature is 400°C .

The vapour from Crude oil passed to tall fractional column from furnace.

The tall fractional column consists of no. of steel trays each tray providing loose cap with a small chimney. As the vapours go up from down of the fractional column they begin to cool, i.e. decrease of temperature and condensation takes place at different levels of the column.

Higher boiling fractions condense first while the lower boiling fractions condensed step-by-step. Thus the crude oil is fractionated into different fractions depending upon their boiling temperatures.

In this process, heavy oil, Diesel, Kerosene, Naptha, petrol, uncondensed gases (LPG) are separated from crude oil.

Retention time :-

Retention time is the amount of time a compound spends on the column after it has been injected.

If a sample containing several compounds, each compound in the sample will spend a different amount of time on the column.



High Performance Liquid Chromatography :- [HPLC].

Liquid Chromatography is a technique is used to separate of a mixture into it's constituents by a moving liquid phase passing over a stationary adsorbent or stationary phase.

Last years, we were used classical liquid column chromatography but no. of problems occur at separation and this process is also slow. . . .

Now a days discovery of high pressure pumps operating at high pressure, the solvent (liquid phase) is passed through the column effectively and high speed. So, this technique is also known as High speed liquid Chromatography & High Performance liquid Chromatography (HPLC).

Principle :- HPLC is an advanced method of Column Chromatography. Even microgram to gram quantities of mixtures can be separated by passage of sample by high pressure flow of a liquid mobile phase through a column containing a stationary solid phase.

The components of a sample mixture get separated due to differences in charge, size, affinity in the stationary phase.

Instrumentation:

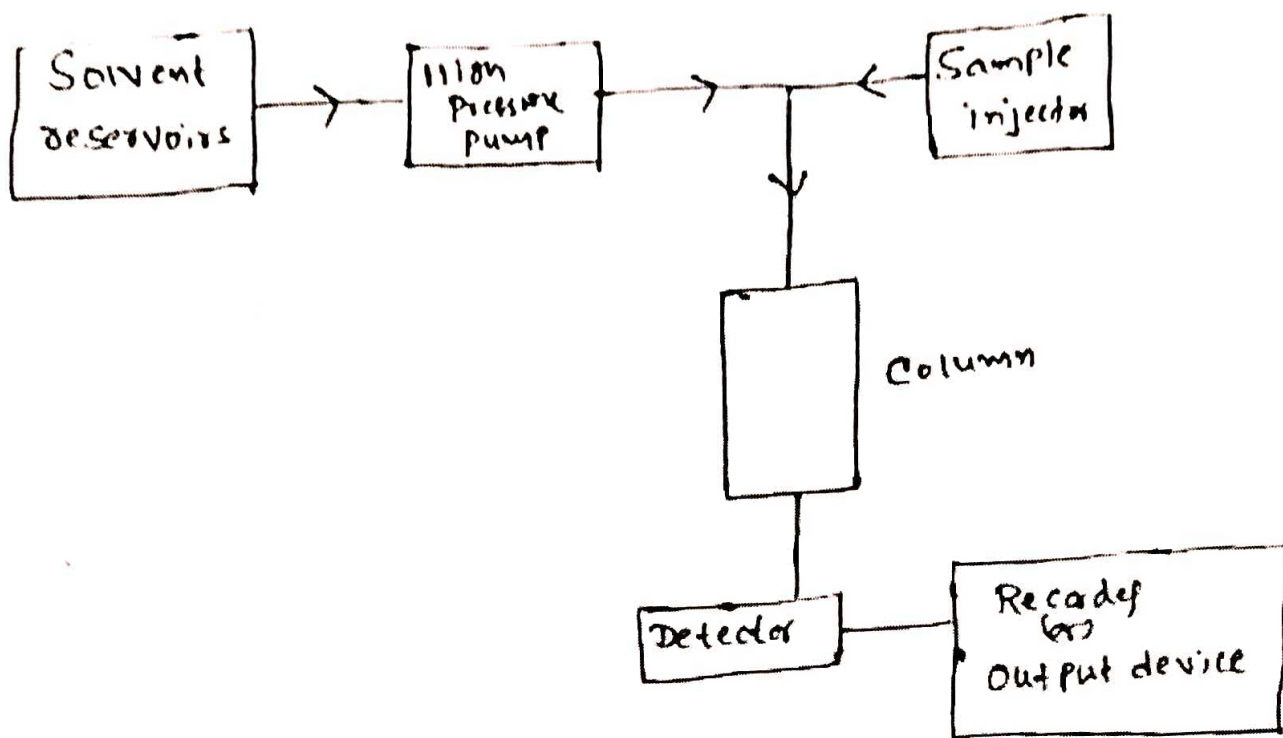

The HPLC - is made up of the following main components

- 1) Solvent reservoirs
- 2) High Pressure Pump
- 3) Sample injection part
- 4) Analytical Column (Stationary Phase)
- 5) Detector and 6) Recorder (or) output device.

Applications:-

- 1) HPLC is mainly used in Pharmaceutical Companies.
- 2) It is used for checking the quality of products in food industry, pesticides industries, etc.
- 3) It is used for separation of vitamins, lipids at low quantities.
- 4) For separation of similar molecule.
- 5) Separation of carbohydrates in a mixture of carbohydrates, etc.